

 POLARIS

RZR



2016

ACCESSORIES, RIDING GEAR & GARAGE

INTERNATIONAL VERSION

POLARIS®

ENGINEERED PARTS
ACCESSORIES & APPAREL

ENGINEERED TO PERFORM

Everything we build is meticulously designed, rigorously tested and obsessively tuned to elevate your off-road experience. From innovative technology, to purpose built accessories, key maintenance essentials, to durable riding gear, our engineers don't just spend countless hours in the shop developing our products. As riders themselves, they personally test our products out on the trails, riding miles and miles through punishing conditions to guarantee that your RZR® and all of our Polaris Engineered Parts, Accessories and Apparel™ provide Razor-Sharp Performance.



"POLARIS ENGINEERED PARTS AND ACCESSORIES™ ARE DEVELOPED BY THE SAME PEOPLE WHO DESIGN THE VEHICLES. NOBODY KNOWS THESE MACHINES BETTER THAN US."

— CLINT J., POLARIS® DESIGNER

2016 POLARIS® RZR®

ACCESSORIES, RIDING GEAR & GARAGE

Polaris Engineered™	01
Innovation	02-03
RZR® Accessory Solutions	04-11
Style & Customization	12-13

ACCESSORIES

Windshields	14
Rear Panels	15
Doors & Roofs	16-19
Bumpers & Guards	20-25
Winches	26-29
Lighting	30-35
Storage & Interior	36-39
Audio	40-43
Tech & Electronics & Performance	44-47
Tires & Wheels	48-51
Plows	52-53
Tracks	54
Youth RZR®	55

RIDING GEAR

Fly Style Combinations	56-59
Helmets	60-61
Goggles	62
Gloves & Jerseys	63
Protection	64
Youth Protection	64
Hats & Layering	65
Men's Casual Apparel	66-67
Women's Casual Apparel	68-69
Youth Casual Apparel	70
Sizing Charts	70
Ogio® Bags	71
Gifts	71

GARAGE

Tool Chests	74
Shop Products	75
Generators	76
Trailers, Ramps & Covers	77
Parts & Fuel Treatments	78
Vehicle Care	79
Oils & Lubricants	80-81



SEE POLARIS ENGINEERED™ VIDEOS
AT POLARIS.COM/RZRACCESSORIES

INNOVATION NEVER RESTS

NEW FOR 2016

Over the past year, we've enhanced our existing products and created over 110 new accessories in every category, all with the goal of helping you to get the most out of your RZR®.

LIGHTING
PAGE 30

AUDIO
PAGE 40

CUSTOMIZATION
PAGE 12

TIRES & WHEELS
PAGE 48

MADE TO MAKE IT YOUR OWN

POLARIS ENGINEERED ACCESSORIES™ ARE DESIGNED WITH INDUSTRY-EXCLUSIVE TECHNOLOGIES RIGHT ALONGSIDE YOUR RZR®, GUARANTEEING QUICK AND SEAMLESS INSTALLATION AND A PERFECT FIT EVERY TIME.



EXPANDED ANCHOR MOUNTS

Tougher than conventional nuts and bolts, Expanded Anchor Mounts are engineered into every RZR®, allowing for a 5 minute or less install of accessories like rock sliders and bumpers without damaging your vehicles' frame.

EASY INSTALL WITH MOUNTING LOCATIONS

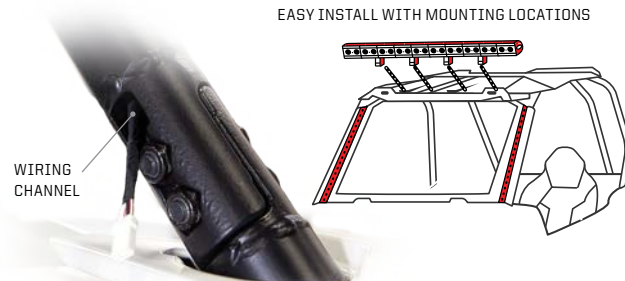

LIGHTING AND AUDIO INTEGRATION

Installation of audio and overhead lighting is easy with specific accessory mounting locations and wiring channels designed into the cage of RZR®, keeping cords protected and wiring clean.



CAB COMPONENTS

Fully customize your cab. The integrated visor engineered into every RZR® provides simple, clean installation of all cab accessories with specific mounting locations for roofs and light bars, providing superior fit, sealing and protection.



LOCK & RIDE

LOCK & RIDE™

Exclusively engineered into every Polaris® vehicle, Lock & Ride® has revolutionized off-road vehicle customization. Every Lock & Ride® accessory is specifically designed to install quickly, without tools and without hassle.

ACCEPT NO SUBSTITUTE FOR YOUR ADRENALINE FIX

There are few places on earth that the RZR® can't take you to, and even fewer when you utilize the power of Polaris Engineered Parts and Accessories™.

CRANK IT UP — AUDIO — PG 18



OPEN UP — DOORS — PG 21

DUNES

Miles and miles of soft, shifting sand is no place for uncertainty. Attack the dunes with confidence.



PROTECT YOUR RIDE — BUMPERS & BRUSHGUARDS — PG 24

DESERT

Performance at its peak in the most inhospitable environments on earth.

GET NOTICED — STYLE — PG 14



ULTIMATE TRACTION — TIRES & WHEELS — PG 56

TRAIL

Whether its rocks, mud or steep terrain, be ready for whatever's around the next turn.

DUNE

Make a statement with your RZR®. With hundreds of Polaris Engineered Accessories™ to choose from, customize your RZR® for a full-on dune rally.



TOP 3 DUNE ACCESSORIES POLARIS® RECOMMENDS

TOP
3

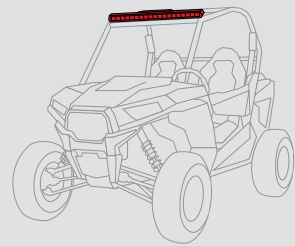

35" LED LIGHT BAR

» PAGE 32

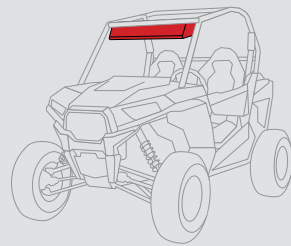

SOUND BAR 8

» PAGE 41

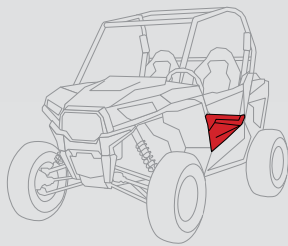

LOWER DOOR INSERTS

» PAGE 17

LIGHT DUNE SOLUTION

Perfect beginner solution to get your RZR® ready for the dunes.

- » RZR® WHIP FLAG | PAGE 39 | 2881468
- » ALUMINUM ROOF | PAGE 19 | 2879443-458
- » HALF WINDSHIELD | PAGE 14 | 2879504
- » LOCK & RIDE® COOLER BOX | PAGE 36 | 2881555
- » LOWER DOOR INSERTS | PAGE 17 | 2879509
- » LOW PROFILE FRONT BUMPER | PAGE 22 | 2879449-133
- » LOW PROFILE REAR BUMPER | PAGE 22 | 2880560-133
- » CONVEX REAR VIEW MIRROR | PAGE 38 | 2880531
- » 13" LIGHT BAR | PAGE 33 | 2880530
- » LED HARNESS | PAGE 44 | 2879859
- » BUSBAR HARNESS | PAGE 44 | 2881551

See audio/light harness chart on page 43 for more info



EXTREME DUNE SOLUTION

From audio to tires, be the center of attention and have everything you need to dominate the dunes in style with this solution.

- » ALUMINUM DOORS | PAGE 16 | 2879510
- » DOOR GRAPHICS | PAGE 16 | 2881640
- » ACCENT LIGHTS | PAGE 34 | 2880500
- » SOUND BAR 8 | PAGE 41 | 2881465
- » AUDIO PODS | PAGE 40 | 2881227
- » HIGH FLOW PERFORMANCE MESH SEATING* | PAGE 39 | 2881469
- » CLICK-6 HARNESSES DRIVER* | PAGE 39 | 2879854
- » CLICK-6 HARNESSES PASSENGER* | PAGE 39 | 2880470
- » ULTIMATE HARNESS | PAGE 44 | 2881617
- » LINE OUT HARNESS | PAGE 44 | 2881652
- » AUDIO Y-HARNESS | PAGE 44 | 2881651
- » SAND TIRE WITH SHACKLE WHEEL | PAGE 51 | 2881538
- » RED ALUMINUM ROOF | PAGE 19 | 2879443-293

- » RZR® WHIP FLAG | PAGE 39 | 2881468

See audio/light harness chart on page 43 for more info

* Not shown



WEEKENDER DUNE SOLUTION

Pile in the family and get ready for a weekend of fun-filled action in the dunes with this solution.

- » RZR® WHIP FLAG | PAGE 39 | 2881468
- » COLOR ALUMINUM ROOF | PAGE 19 | 2879939-458
- » WINDSHIELD | PAGE 14 | 2879504
- » LOCK & RIDE® COOLER BOX | PAGE 36 | 2881555
- » BULL BUMPER - FRONT | PAGE 21 | 2881202-458
- » BULL BUMPER - REAR | PAGE 21 | 2881472-458
- » BLUETOOTH® AUDIO REMOTE* | PAGE 41 | 2881470
- » 35" UNDER ROOF LIGHT BAR MOUNT | PAGE 32 | 2881553
- » POLY LOWER DOORS | PAGE 41 | 2881465
- » EXTREME AUDIO PODS | PAGE 40 | 2881227
- » RZR® HIGH FLOW MESH PERFORMANCE SEAT* | PAGE 39 | 2881469
- » 35" LIGHT BAR | PAGE 32 | 2880527
- » ULTIMATE HARNESS | PAGE 43 | 2881617
- » LINE OUT (x2) | PAGE 44 | 2881652
- » AUDIO Y-HARNESS | PAGE 44 | 2881651
- » SAND TIRES & WHEELS PACKAGE | PAGE 51 | 2881358
- » BUSBAR HARNESS | PAGE 44 | 2881646

See audio/light harness chart on page 43 for more info

* Not shown



DESERT

Equip your RZR® with the perfect combination of performance and style. Polaris Engineered Accessories™ allow you to make the most out of your desert adventure.



TOP 3 DESERT ACCESSORIES POLARIS® RECOMMENDS

TOP
3

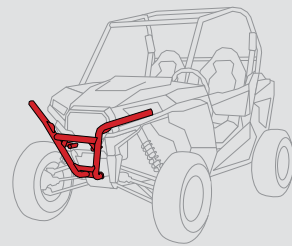

LOW PROFILE FRONT BUMPER

» PAGE 22

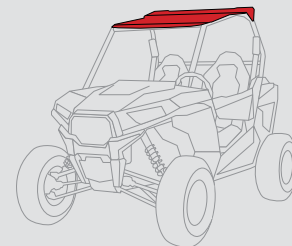

ALUMINUM ROOF

» PAGE 19

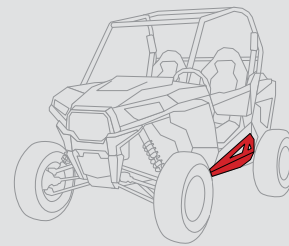

LOW PROFILE STEEL ROCK SLIDERS

» PAGE 24

LIGHT DESERT SOLUTION

Conquer every jagged rock, massive boulder and steep climb.

- » ALUMINUM ROOF | PAGE 21 | 2879443-458
- » LOW PRO FRONT | PAGE 22 | 2879449-458
- » LOW PRO REAR | PAGE 22 | 2880560-458
- » CARGO BAG | PAGE 36 | 2881204
- » CANNON LIGHTS (2X) | PAGE 32 | 2881471
- » WIDE ANGLE MIRROR | PAGE 38 | 2881199
- » AUDIO Y-HARNESS | PAGE 44 | 2879860
- » LED HARNESS | PAGE 44 | 2879859
- » BUSBAR HARNESS | PAGE 44 | 2881551
- » LED Y-HARNESS | PAGE 43 | 2879860

See audio/light harness chart on page 43 for more info



EXTREME DESERT SOLUTION

Take on the very worst environments you can find.

- » DELUXE - FRONT BUMPER | PAGE 21 | 2879449-293
- » GRAPHIC ROOF | PAGE 18 | 2881206
- » ALUMINUM DOORS | PAGE 16 | 2879510
- » UPPER DOOR NETS* | PAGE 17 | 2881654
- » INTRUSION BAR | PAGE 22 | 2879181
- » UPPER CAB FRAME EXTENDER | PAGE 23 | 2880411
- » LOWER CAB FRAME EXTENDER | PAGE 23 | 2880412
- » SPARE TIRE CARRIER | PAGE 38 | 2880148
- » JACK KIT | PAGE 38 | 2881201
- » 30" LED LIGHT BAR | PAGE 32 | 2881324
- » BUSBAR HARNESS | PAGE 44 | 2879862
- » LED HARNESS | PAGE 44 | 2879859

See audio/light harness chart on page 43 for more info
* Not shown



PREMIUM DESERT SOLUTION

Desert conditions are unforgiving. Sacrifice nothing.

- » COLOR ALUMINUM ROOF | PAGE 21 | 2881582-630
- » COLOR LOW PRO FRONT | PAGE 22 | 2881583-630
- » COLOR LOW PRO REAR | PAGE 22 | 2881585-630
- » HIGH CLEARANCE A-ARMS | PAGE 49 | 2880796-458
- » HIGH CLEARANCE REAR RODS | PAGE 49 | 2879523-458
- » CONVEX REAR VIEW MIRROR | PAGE 38 | 2880531
- » SKID PLATE* | PAGE 25 | 2879455
- » 35" LIGHT BAR | PAGE 32 | 2880527
- » PRO HD 4500 LB WINCH | PAGE 29 | 2881672
- » LED HARNESS | PAGE 44 | 2879859
- » BUSBAR HARNESS | PAGE 44 | 2879862
- » HIGH FLOW MESH PERFORMANCE SEAT | PAGE 39 | 2881469
- » CLICK-6 HARNESSES DRIVER* | PAGE 39 | 2879854
- » CLICK-6 HARNESSES PASSENGER* | PAGE 39 | 2880470
- » LOCK & RIDE® COOLER BOX | PAGE 36 | 2881555
- » SPARE TIRE CARRIER | PAGE 38 | 2879464
- » CRAWLER TIRE WITH BUCKLE WHEEL | PAGE 51 | 2881561

See audio/light harness chart on page 43 for more info

* Not shown



TRAIL

When you're winding through the trees and tearing up the trail, do so confidently. Polaris Engineered Accessories™ supply your RZR® with storage, protection and comfort options so that you're ready for anything.



TOP 3 TRAIL ACCESSORIES POLARIS® RECOMMENDS

TOP
3

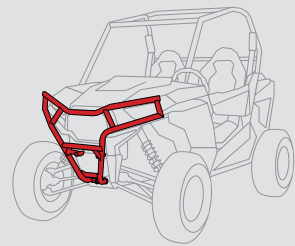

DELUXE FRONT BUMPER
» PAGE 21

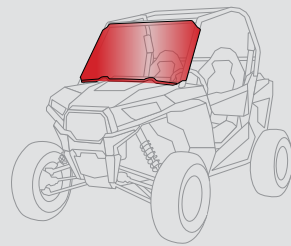

LOCK & RIDE® WINDSHIELD
» PAGE 14

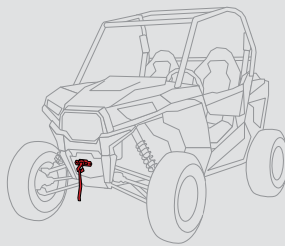

PRO HD 4500 LB. WINCH
» PAGE 28

LIGHT TRAIL SOLUTION

From dusty trails to sloppy conditions, be ready for anything.

- » ALUMINUM ROOF | PAGE 21 | 2879443-458
- » LOW PRO FRONT | PAGE 22 | 2879449-458
- » LOWER DOOR INSERTS | PAGE 17 | 2879509
- » LOCK & RIDE® FULL POLY WINDSHIELD | PAGE 14 | 2880501
- » 30" LED LIGHT BAR | PAGE 32 | 2881324
- » UNDER VISOR LIGHT BAR MOUNT (30") | PAGE 32 | 2881203
- » POLARIS® HD 3500 LB. WINCH | PAGE 29 | 2881671
- » CARGO BAG | PAGE 36 | 2881204
- » UPPER DOOR BAG* | PAGE 37 | 2880612
- » BUSBAR HARNESS | PAGE 44 | 2881551
- » LED HARNESS | PAGE 44 | 2879859

*Not shown



EXTREME TRAIL SOLUTION

Increased protection, performance and styling.

- » ALUMINUM ROOF | PAGE 21 | 2879443-458
- » LOW PROFILE BUMPER - FRONT | PAGE 21 | 2879449-293
- » LOCK & RIDE® FULL POLY WINDSHIELD | PAGE 14 | 2880501
- » 30" LED LIGHT BAR | PAGE 32 | 2881324
- » ALUMINUM DOORS | PAGE 16 | 2879510
- » POLARIS® HD 3500 LB. WINCH | PAGE 29 | 2881671
- » CARGO BAG | PAGE 36 | 2881204
- » SOUND BAR 8 | PAGE 41 | 2881465
- » BUSBAR HARNESS | PAGE 44 | 2881551
- » ULTIMATE HARNESS | PAGE 44 | 2881617
- » LINE OUT HARNESS | PAGE 44 | 2881652
- » AUDIO Y-HARNESS | PAGE 44 | 2881651

See audio/light harness chart on page 43 for more info
*Not shown

PREMIUM TRAIL SOLUTION

Twists and turns and trees and tough terrain have met their match.

- » ALUMINUM ROOF | PAGE 19 | 2879939-458
- » LOW PRO FRONT | PAGE 22 | 2879449-458
- » LOCK & RIDE® HALF WINDSHIELD | PAGE 14 | 2879504
- » CANNON LIGHTS (X2) | PAGE 32 | 2881471
- » DELUXE LED HARNESS | PAGE 44 | 2879865
- » LOWER POLY DOORS 4 | PAGE 17 | 2879942
- » LOCK & RIDE® COOLER BOX | PAGE 36 | 2881556
- » SOUND BAR 8 | PAGE 41 | 2881465
- » BUSBAR HARNESS | PAGE 44 | 2880055

See audio/light harness chart on page 43 for more info



IT'S NOT JUST A RZR.[®] IT'S YOUR RZR.[®]

Go beyond stock with a wide selection of roofs, bumpers, doors and rock sliders available in a variety of colors and graphic options specifically designed to accent the aggressive styling of your machine. Don't let the dust settle. Add a custom audio solution and lights to ride into the night.

CUSTOM ALUMINUM DOOR GRAPHICS

PAGE 16

GRAPHIC SPORT ROOF

PAGE 18

EXTREME AUDIO PODS

PAGE 40

ACCENT LIGHTING

PAGE 34

WINDSHIELDS



GLASS WINDSHIELD

- Laminate safety glass for excellent scratch resistance
- Installs in minutes and integrates into a designated mounting position
- Windshield surface seals directly to the visor with no additional framework needed
- Increased visibility with a reduction of framework
- Offers maximum protection and durability from wind, rain and off-road hazards

» 2879447

RZR® XP 1000 MY 14-16, RZR® XP 4 1000 MY 14-16, RZR® 900 MY 15-16, RZR® S 900 MY 15-16, RZR® 900 XC MY 15-16, RZR® 4 900 MY 15-16, RZR® S 1000 MY 16, RZR® XP TURBO MY 16

This windshield works with accessory Windshield Wiper Kit (2879526), see page 47



FLIP-DOWN POLY WINDSHIELD

- Versatile, adjustable windshield lets riders customize airflow and protection
- Windshield can be closed (up position) for full coverage, opened slightly for airflow or laid flat on hood (wide open)
- Enhances rider comfort, protection and visibility in all riding conditions
- Windshield position can be adjusted easily as riding conditions change
- Material is .236" polycarbonate construction with hard coat on both sides that is impact, shatter and scratch resistant.
- Mounts easily into vehicle frame in designated mounting locations

» 2879505

RZR® XP 1000 MY 14-16, RZR® XP 4 1000 MY 14-16, RZR® 900 MY 15-16, RZR® S 900 MY 15-16, RZR® 900 XC MY 15-16, RZR® 4 900 MY 15-16, RZR® S 1000 MY 16, RZR® XP TURBO MY 16



LOCK & RIDE® WINDSHIELD

- Lock & Ride®: Installs quickly and easily without tools
- Durable, optical-grade polycarbonate for maximum impact resistance, with no frame for maximum visibility
- Seals fully on cab frame and hood for optimized protection
- Integrates with all cab components

» 2880501

RZR® XP 1000 MY 14-16, RZR® XP 4 1000 MY 14-16, RZR® 900 MY 15-16, RZR® S 900 MY 15-16, RZR® 900 XC MY 15-16, RZR® 4 900 MY 15-16, RZR® S 1000 MY 16, RZR® XP TURBO MY 16

» 2879492 (NOT SHOWN)

RZR® 570 MY 12-16, RZR® 800 MY 08-14, RZR® S MY 09-14, RZR® 4 MY 10-14, RZR® 900 MY 11-14, RZR® 900 4 MY 11-14



LOCK & RIDE® HALF WINDSHIELD

- Provides protection and delivers optimum airflow into the cab
- Ideal for high heat/dust conditions
- Strong, durable, impact-resistant polycarbonate
- Unique shape directs airflow and dust away from occupants
- Lock & Ride®: Installs quickly and easily without tools
- Fully-sealed lower section of windshield to hood

» 2879504

RZR® XP 1000 MY 14-16, RZR® XP 4 1000 MY 14-16, RZR® 900 MY 15-16, RZR® S 900 MY 15-16, RZR® 900 XC MY 15-16, RZR® 4 900 MY 15-16, RZR® S 1000 MY 16, RZR® XP TURBO MY 16

» 2879493 (NOT SHOWN)

RZR® 570 MY 12-16, RZR® 800 MY 08-14, RZR® S MY 09-14, RZR® 4 MY 10-14, RZR® 900 MY 11-14, RZR® 900 4 MY 11-14

REAR PANELS



LOCK & RIDE® POLY REAR PANEL / NEW

- Outstanding protection from dust and swirl, especially when used with windshield (sold separately)
- Constructed from thick, impact resistant polycarbonate
- Reduces cockpit noise while still delivering full rearward visibility
- Premium style, fit and finish.
- Installs quickly & easily utilizing Lock & Ride® technology

» 2881613

RZR® 1000 S MY16, RZR® 4 900 MY15-16, RZR® 900 MY14-16, RZR® 900 S MY15-16, RZR® 900 XC EDITION MY15-16

» 2881614 (NOT SHOWN)

RZR® XP® 1000 MY14-16, RZR® XP® 4 1000 MY14-16, RZR® XP® TURBO MY16

» 2878752 (NOT SHOWN)

RZR® 570 MY12-16, RZR® 800 MY08-15, RZR® S MY09-14, RZR® 900 MY11-14



CANVAS REAR PANEL

- Provides reliable protection and enhanced comfort, at a price point that delivers outstanding value
- The 23-oz. polyester canvas is mold-resistant for long-term performance and UV-stable to resist fading from prolonged exposure to sunlight
- The large vinyl window provides excellent rearward visibility while letting light into the cab
- This rear panel installs in minutes in designated mounting positions on the vehicle frame
- Requires minimal tools for installation
- Can be used along with additional RZR® accessories such as windshields, roofs, doors, audio systems, mirrors, auxiliary lights and more (each sold separately)

» 2880608

RZR® 900 MY 15-16, RZR® S 900 MY 15-16, RZR® 900 XC MY 15-16, RZR® 4 900 MY 15-16, RZR® S 1000 MY 16



MESH REAR PANEL

- Mesh Rear Panel gives RZR® riders a stylish race look as well as rearward visibility and airflow
- Heavy-duty mesh fabric provides modest shade and protection from inclement weather
- Rear panel installs quickly and easily to vehicle frame using provided straps
- When not needed, the rear panel can be removed and stored in the vehicle
- Stylish rear panel features Polaris® branding and is similar to rear panel used by Polaris® RZR® racers
- Rear panel can be used with RZR® accessories such as windshields, roofs, doors, audio systems, mirrors, auxiliary lighting and more (each sold separately)

» 2880409

RZR® 900 MY 15-16, RZR® S 900 MY 15-16, RZR® 900 XC MY 15-16, RZR® 4 900 MY 15-16, RZR® S 1000 MY 16

» 2879507

RZR® XP 1000 MY 14-16, RZR® XP 4 1000 MY 14-16, RZR® XP TURBO MY 16

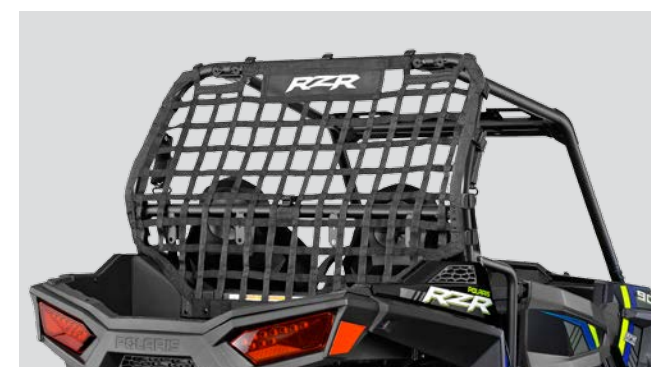

REAR RACE NET

- Ultra-strong and durable fabric net construction
- Net construction provides rearward visibility and airflow
- Easy to install: It attaches to the vehicle framework using provided mounting hardware
- Easy to store: Rear panel can be rolled or folded and stored in the vehicle when not needed
- Custom reflective RZR® graphic for increased night time visibility

» 2880408

RZR® 900 MY 15-16, RZR® S 900 MY 15-16, RZR® 900 XC MY 15-16, RZR® 4 900 MY 15-16, RZR® S 1000 MY 16

» 2879936

RZR® XP 1000 MY 14-16, RZR® XP 4 1000 MY 14-16, RZR® XP TURBO MY 16

DOORS

OPEN UP AND GET RIDING.

Whether you're looking to reduce the amount of dirt, dust and debris entering the cab with door inserts, or want to add an aggressive look with stylish graphics, we've got you covered.



ALUMINUM DOORS

- Race-inspired, strong, durable, aluminum construction ensures reliable protection, a great fit and enhanced style
- Highly integrated and installs in minutes; replaces existing door plastics and utilizes stock hardware
- Gives vehicle finished, full-custom look and also increases rider protection
- Latches and hinges feature strong, durable, reliable steel construction, and gasket design eliminates rattling
- Can be equipped with accessory graphic wraps (sold separately)

» 2879510

RZR® XP 1000 MY 14-16, RZR® S 900 MY 15-16, RZR® XC MY 15-16, RZR® S 1000 MY 16, RZR® XP TURBO MY 16

» 2879943

RZR® XP 4 1000 MY 14-16, RZR® 4 900 MY 15-16

RZR® BLACK POWDER-COAT FINISH DOORS (NOT SHOWN)

» 2879614

RZR® 570 MY 12-16, RZR® 800 MY 11-14, RZR® S MY 11-14, RZR® 900 MY 11-14

ALUMINUM DOOR GRAPHICS / NEW

- Continuation of factory graphic scheme for accessory Aluminum Doors
- Requires Aluminum Doors (2879510), sold separately

» 2881638 | Spectra Orange

RZR® XP 1000 MY 14-16, RZR® XP TURBO MY 16, RZR® 1000 S MY 16, RZR® 900 S MY 15-16, RZR® 900 XC EDITION MY 16

» 2881640 | Super Graphite

RZR® XP 1000 MY 14-16, RZR® XP TURBO MY 16, RZR® 1000 S MY 16, RZR® 900 S MY 15-16, RZR® 900 XC EDITION MY 16

» 2881643 | Velocity Blue

RZR® XP 1000 MY 14-16, RZR® XP TURBO MY 16, RZR® 1000 S MY 16, RZR® 900 S MY 15-16, RZR® 900 XC EDITION MY 16

» 2881644 | Electric Blue Metallic

RZR® XP 1000 MY 14-16, RZR® XP TURBO MY 16, RZR® 1000 S MY 16, RZR® 900 S MY 15-16, RZR® 900 XC EDITION MY 16

» 2881645 | Titanium Lime Squeeze

RZR® XP 1000 MY 14-16, RZR® XP TURBO MY 16, RZR® 1000 S MY 16, RZR® 900 S MY 15-16, RZR® 900 XC EDITION MY 16



LOWER DOOR INSERTS

- Durable plastic construction with steel frame
- Highly integrated and installs in minutes, bolting to existing door utilizing stock hardware
- Gasket designed to eliminate rattles and supply added sealing
- Styled to match the your RZR™'s design lines so they fit in seamlessly
- Protection from the elements keeps mud and dust out from the inside of the vehicle

» 2879509

RZR® XP 1000 MY 14-16, RZR® S 900 MY 15-16, RZR® XC MY 15-16, RZR® S 1000 MY 16, RZR® XP TURBO MY 16

» 2880207

RZR® 900 MY 15-16

» 2879942

RZR® XP 4 1000 MY 14-16, RZR® 4 900 MY 15-16



LOWER DOOR INSERTS

UPPER DOOR INSERTS

DOOR LINERS

- Durable, weatherproof construction for reliable performance during off-road riding
- Upper Door Liners feature modest padding to provide passengers with enhanced comfort while riding
- Liners are styled to coordinate with upholstery of vehicle's rear seats for a finished, integrated look
- Liners install easily, attaching to interior door framework
- Upper Door Liners are branded with Polaris® logo, Lower Door Liners are branded with RZR® logo

» 2879996 | Upper Front Door Liner

RZR® 900 MY 15-16

» 2879431 | Upper Front Door Liner

RZR® S 900 MY 15-16, RZR® 900 XC MY 15-16, RZR® XP 1000 MY 14-16, RZR® XP 4 1000 MY 14-16, RZR® 4 900 MY 15-16, RZR® S 1000 MY 16, RZR® TURBO MY 16

» 2880703 | Upper Rear Door Liner

RZR® XP 4 1000 MY 14-16, RZR® 4 900 MY 15-16

» 2879432 | Lower Front Door Liner

RZR® 900 MY 15-16

Only fits with Lower Door Inserts (2880207)

» 2879433 | Lower Front Door Liner

RZR® S 900 MY 15-16, RZR® 900 XC MY 15-16, RZR® XP 1000 MY 14-16, RZR® XP 4 1000 MY 14-16, RZR® 4 900 MY 15-16, RZR® S 1000 MY 16, RZR® TURBO MY 16

Only fits with Lower Door Inserts (2879509)

» 2880704 | Lower Rear Door Liner

RZR® XP 4 1000 MY 14-16, RZR® 900 4 MY 15-16

Only fits with Lower Door Inserts (2879942)



UPPER DOOR NETS / NEW

- Features aluminum framing and high-strength nylon webbing
- Fits between lower doors and over-structure
- Delivers added style for performance off-road applications
- Includes all necessary mounting hardware

» 2881654

RZR® XP 1000 MY 14-16, RZR® XP TURBO MY 16, RZR® 1000 S MY 16, RZR® 900 MY 14-16, RZR® 900 S MY 15-16, RZR® 900 XC EDITION MY 15-16



CANVAS UPPER HALF DOORS

- High-quality, durable polyester for UV protection and mildew resistance
- Rugged vinyl window that is UV and cold-crack resistant
- Requires purchase of lower half doors (2879509; sold separately) or Aluminum Doors (2879943; sold separately) for complete full doors
- The canvas door perimeter is mounted on a sturdy steel tubular frame that ensures the upper door holds its shape

» 2879902

RZR® XP 1000 MY 14-16, RZR® S 900 MY 15-16, RZR® XC MY 15-16, RZR® S 1000 MY 16, RZR® XP TURBO MY 16

» 2879946

RZR® XP 4 1000 MY 14-16, RZR® 4 900 MY 15-16

» 2880609

RZR® 900 MY 15-16

Only recommended for use with Polaris® full windshield and lower poly doors. Also works with aluminum doors. Sold separately for full doors (2880609). Recommended to be used with canvas rear panel (2880608). Does not work with any type of Sport Roof due to overhang.

ROOFS



PROTECTION AGAINST THE ELEMENTS.

Protection. Shade. Aggressive styling. There's no shortage of reasons to add Polaris Engineered™ roofs, which are designed and built for a perfect fit.



GRAPHIC SPORT ROOF / NEW

- Stylish molded roof available in black or red with complimenting graphics
- Provides protection from the elements including sun, snow, sleet and rain but will not bend or deform if struck by debris
- Durable molded construction engineered to retain its shape in extreme heat
- Includes all necessary mounting hardware for easy installation
- Sun roof lets some light through while still keeping you shaded from the heat

- » **BLACK | 2881206**
RZR XP® 1000 MY14-16, RZR XP® TURBO MY16, RZR® 1000 S MY16, RZR® 900 MY14-16, RZR® 900 S MY15-16, RZR® 900 XC MY15-16
- » **INDY RED | 2881607**
RZR XP® 1000 MY14-16, RZR XP® TURBO MY16, RZR® 1000 S MY16, RZR® 900 MY14-16, RZR® 900 S MY15-16, RZR® 900 XC MY15-16
- » **BRIGHT WHITE | 2881608**
RZR XP® 1000 MY14-16, RZR XP® TURBO MY16, RZR® 1000 S MY16, RZR® 900 MY14-16, RZR® 900 S MY15-16, RZR® 900 XC MY15-16



ALUMINUM ROOF

- Stylish and functional, this roof provides color-coordinated style, shade and outstanding overhead protection
- This roof seals to the vehicle frame for the best protection and great integration with other RZR® accessories
- Durable powder-coat finish coordinates with the vehicle's bodywork and matching accessories
- Strong and durable 5051 aluminum construction for long-lasting reliable protection
- Roof can be used with RZR® accessories such as windshields, rear panels, doors, audio systems, auxiliary lighting and more (each sold separately)

- » **BLACK | 2879443-458**
- » **LIME SQUEEZE | 2881582-630**
- » **SPECTRA ORANGE | 2881582-697**
- » **INDY RED | 2879443-293**
- » **BRIGHT WHITE | 2879443-133**
RZR® XP 1000 MY 14-16, RZR® 900 MY 15-16, RZR® S 900 MY 15-16, RZR® 900 XC MY 15-16, RZR® S 1000 MY16, RZR® XP TURBO MY 16
- » **BLACK | 2879939-458**
- » **LIME SQUEEZE | 2881592-630**
- » **SPECTRA ORANGE | 2881592-697**
- » **INDY RED | 2879939-293**
- » **BRIGHT WHITE | 2879939-133**
RZR® XP 4 1000 MY 14-16, RZR® 4 900 MY 15-16



CANVAS ROOF

- Durable, heavyweight 23-oz. polyester canvas construction
- Mold-resistant and UV-stable to resist fading for long-lasting performance
- Installs quickly and easily with provided straps

- » **2880561**
RZR® XP 1000 MY 14-16, RZR® 900 MY 15-16, RZR® S 900 MY 15-16, RZR® 900 XC MY 15-16, RZR® S 1000 MY16, RZR® XP TURBO MY 16
- » **2880610**
RZR XP® 4 1000 MY14-16, RZR® 4 900 MY15-16



LOCK & RIDE® POLY SPORT ROOF

- Rigid injection-molded design to eliminate warping in high-heat conditions
- Integrated mounting locations for lighting
- Lock & Ride®: Installs quickly and easily without tools

- » **2879442**
RZR® XP 1000 MY 14-16, RZR® 900 MY 15-16, RZR® S 900 MY 15-16, RZR® 900 XC MY 15-16, RZR® S 1000 MY16, RZR® XP TURBO MY 16
- » **2879937**
RZR® XP 4 1000 MY 14-16, RZR® 4 900 MY 15-16



LOCK & RIDE® SPORT ROOF

- Lock & Ride®: Installs quickly and easily without tools
- Rigid injection-molded design to eliminate warping in high-heat conditions
- Rugged textured polyethylene construction for impact and abrasion resistance
- Integrated LED mounting locations
- Aggressive styling to match the RZR® design

- » **2878748**
RZR® 570 MY 12-16, RZR® 800 MY 08-14, RZR® S MY 09-14, RZR® 900 MY 11-14
- » **2878903**
RZR® 4 MY 10-14, RZR® 900 4 MY 12-14



"I always ride with a roof, it keeps the sun out of my eyes.
Would you build a house without a roof?"

— CHAD G., POLARIS OWNER AND RACER

BUMPERS & GUARDS

THE WORLD IS TOUGH. BE TOUGHER.

Withstand with style. Protect your RZR® with our tough-as-nails bumpers and guards. Featuring color options coordinated to your machine, these accessories install in minutes using exclusive expansion anchor technology, and will endure just about anything.



BULL BUMPER FRONT / NEW

- Profiled, oval tubing provides direct impact protection
- Mounts quickly and securely to factory mount locations
- Shaped to perfectly compliment RZR® styling.
- Built in mounting location for accessory lights
- Recommended with 13" Light Bar (2880530) or Light Cannons (2881471)

- » BLACK | 2881202-458
- » LIME SQUEEZE | 2881202-630
- » SPECTRA ORANGE | 2881202-446
- » INDY RED | 2881202-293
- » VELOCITY BLUE | 2881472-689
- » BRIGHT WHITE | 2881202-133

RZR XP® 1000 MY14-16, RZR XP® 4 1000 MY14-16, RZR XP® TURBO MY16, RZR® 1000 S MY16, RZR® 4 900 MY15-16, RZR® 900 MY14-16, RZR® 900 S MY15-16, RZR® 900 XC EDITION MY15-16



BULL BUMPER REAR / NEW

- » BLACK | 2881472-458
- » LIME SQUEEZE | 2881472-630
- » SPECTRA ORANGE | 2881472-446
- » INDY RED | 2881472-293
- » VELOCITY BLUE | 2881472-689
- » BRIGHT WHITE | 2881472-133

RZR XP® 1000 MY14-16, RZR XP® 4 1000 MY14-16, RZR XP® TURBO MY16



DELUXE FRONT BUMPERS

- Ideal for trail riding; strong, durable protection for front-end components, including headlights
- 1.5" diameter steel tube construction
- Durable powder-coat finish that complements the look of the vehicle's framework
- Installs easily using expanding anchor technology in pre-drilled mounting locations on the vehicle
- Can be used in conjunction with accessories such as a winch, plow system, auxiliary lighting, etc.

- » BLACK | 2880166-458
- » LIME SQUEEZE | 2881591-630
- » INDY RED | 2880166-293
- » BRIGHT WHITE | 2880166-133

RZR® 900 MY 15-16, RZR® S 900 MY 15-16, RZR® 900 XC MY 15-16, RZR® XP 1000 MY 14-16, RZR® XP 4 1000 MY 14-16, RZR® 4 900 MY 15-16, RZR® S 1000 MY 16, RZR® XP TURBO MY 16



DELUXE REAR BUMPERS

- » BLACK | 2880164-458
- » LIME SQUEEZE | 2881590-630
- » INDY RED | 2880164-293
- » BRIGHT WHITE | 2880164-133

RZR® 900 MY 15-16, RZR® S 900 MY 15-16, RZR® 900 XC MY 15-16, RZR® 4 900 MY 15-16, RZR® S 1000 MY 16

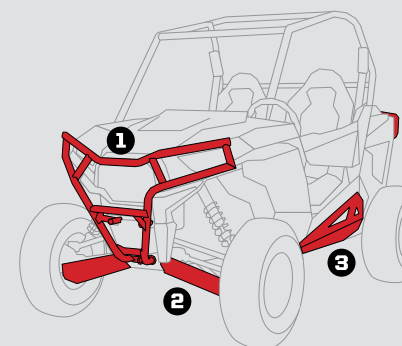

PURPOSE-BUILT PROTECTION FOR DIFFERENT RIDING LANDSCAPES.

1. BUMPERS & BRUSH GUARDS

Shield the front from direct impacts while riding, and cover the back from reversing into objects.

2. A-ARM GUARDS & SKID PLATES

Protect your suspension from low-lying threats such as rocky, uneven terrain and dramatic shifts in elevation.

3. ROCK SLIDERS

Protect the lower body panels from rocks, stumps, and other off-road hazards without losing ground clearance.

BUMPERS & GUARDS CONTINUED

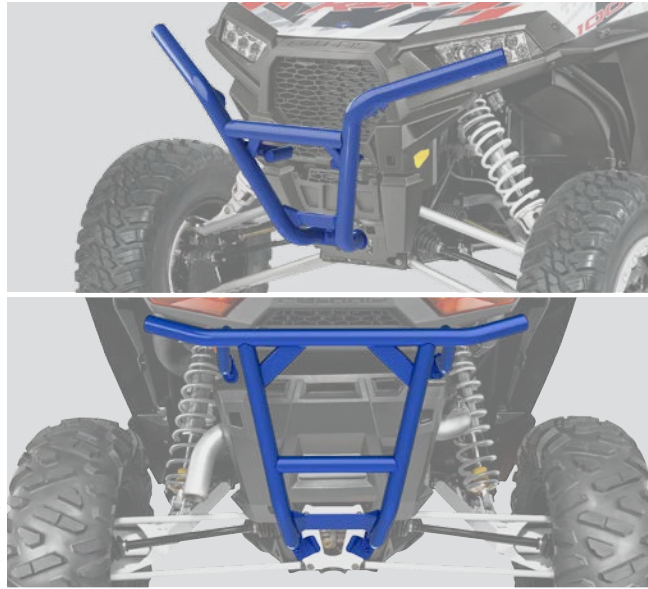

LOW PROFILE FRONT BUMPER

- Material: 1 1/4" diameter steel tube
- Quick installation into designated mounting points
- Durable powder-coated finish
- Integrated light mounting
- Uses expanded anchor technology for install
- Low profile design provides protection for the front of the vehicle

- » BLACK | 2879449-458
- » LIME SQUEEZE | 2881583-630
- » SPECTRA ORANGE | 2881583-446
- » INDY RED | 2879449-293
- » VELOCITY BLUE | 2881583-689
- » BRIGHT WHITE | 2879449-133

RZR® 900 MY 15-16, RZR® S 900 MY 15-16, RZR® 900 XC MY 15-16, RZR® XP 1000 MY 14-16, RZR® XP 4 1000 MY 14-16, RZR® 4 900 MY 15-16, RZR® S 1000 MY 16, RZR® XP TURBO MY 16

LOW PROFILE REAR BUMPER

- » BLACK | 2880560-458
- » LIME SQUEEZE | 2881589-630
- » SPECTRA ORANGE | 2881589-446
- » INDY RED | 2880560-293
- » VELOCITY BLUE | 2881589-689
- » BRIGHT WHITE | 2880560-133

RZR® XP 1000 MY 14-16, RZR® XP 4 1000 MY 14-16, RZR® XP TURBO MY 16



EXTREME ATTACHMENT FRONT BUMPER

- Cast steel corners for headlight and taillight protection and style
- Durable powder coat finish
- 1 1/4" thick steel tube
- Installs onto Low Profile Bumper
- Durable matte black powder-coated finish
- Integrated light mounting
- Uses expanded anchor technology for install

- » BLACK | 2879451-458
- » LIME SQUEEZE | 2881584-630
- » SPECTRA ORANGE | 2881584-446
- » INDY RED | 2879451-293
- » VELOCITY BLUE | 2881584-689
- » BRIGHT WHITE | 2879451-133

RZR® 900 MY 15-16, RZR® S 900 MY 15-16, RZR® 900 XC MY 15-16, RZR® XP 1000 MY 14-16, RZR® XP 4 1000 MY 14-16, RZR® 4 900 MY 15-16, RZR® S 1000 MY 16, RZR® XP TURBO MY 16

Requires Low Profile Front Bumper (2879449-458)

EXTREME ATTACHMENT REAR BUMPER

- » BLACK | 2879452-458
- » LIME SQUEEZE | 2881585-630
- » SPECTRA ORANGE | 2881585-446
- » INDY RED | 2879452-293
- » VELOCITY BLUE | 2881585-689
- » BRIGHT WHITE | 2879452-133

RZR® XP 1000 MY 14-16, RZR® XP 4 1000 MY 14-16, RZR® XP TURBO MY 16

Requires Low Profile Rear Bumper (2880560-458)



INTRUSION BAR

- Lightweight, durable welded steel construction
- Bolts to existing RZR® XP 1000 frame
- Provides race-inspired styling to your machine
- Can be used with other accessories such as audio systems and auxiliary lighting

» 2879181

RZR® XP 1000 MY 14-16, RZR® XP 4 1000 MY 14-16, RZR® 900 MY 15-16, RZR® S 900 MY 15-16, RZR® 900 XC MY 15-16, RZR® S 1000 MY 16, RZR® XP TURBO MY 16, RZR® 4 900 MY 15-16

Will not work with any full windshield



DOMINATING DAKAR

POLARIS RZR® HAS DOMINATED THE LIGHT-VEHICLE CLASS, TAKING 1ST PLACE FOUR YEARS RUNNING AT THE WORLD'S MOST DEMANDING OFF-ROAD RACE - THE DAKAR RALLY. BEING ABLE TO FINISH THE RACE INTACT IS OFTEN HAILED AS A VICTORY. TAKING TO THE PODIUM YEAR AFTER YEAR - NOW THAT IS A TRUE TESTIMONY TO THE UNCOMPROMISING RELIABILITY AND DEPENDABILITY OF POLARIS ENGINEERING.



WINCH INSTALLS DIRECTLY TO BUMPER

EXTREME DUTY BUMPER

- Constructed from 1.75" diameter steel tubing
- Durable powder-coated black finish
- Factory fit installation into existing frame mounting points
- Integrated winch mounting shelf (winch sold separately)
- Integrated high-strength D-rings

» 2880479-458

RZR® XP® 1000 MY14-16, RZR® XP® 4 1000 MY14-16, RZR® XP® TURBO MY16, RZR® 1000 S MY16, RZR® 4 900 MY15-16, RZR® 900 MY14-16, RZR® 900 S MY15-16, RZR® 900 XC EDITION MY15-16

UPPER REAR CAB FRAME EXTENSIONS



LOWER REAR CAB FRAME EXTENSIONS



UPPER REAR CAB FRAME EXTENSIONS

- Strong, durable, cast steel construction
- Provides enhanced protection for the rear of the vehicle and multiple accessory mounting opportunities
- Offers numerous versatile tie-down and connection points for bungees, straps, cargo nets, etc.
- Premium black powder-coat finish coordinates with vehicle's framework
- Gives the vehicle race-inspired style
- Installs easily in designated mounting location on vehicle's frame
- Attaches directly to the Lower Rear Cab Frame Extension (sold separately, 2880412) or Bumper Adapter (sold separately, 2880165) to connect with applicable rear brushguard

» 2880411

RZR® 900 MY 15-16, RZR® S 900 MY 15-16, RZR® 900 XC MY 15-16, RZR® S 1000 MY 16

LOWER REAR CAB FRAME EXTENSIONS

» 2880412

RZR® 900 MY 15-16, RZR® S 900 MY 15-16, RZR® 900 XC MY 15-16, RZR® S 1000 MY 16

Requires the Upper Rear Cab Frame Extension (sold separately, 2880411)



BUMPER ADAPTER

- Bumper Adapter connects Upper Cab Frame Extension with rear bumper (each sold separately, 2880411 and 2880164-458)
- Strong and durable cast steel construction
- Adapters bolt into place quickly and easily in designated mounting points

» 2880165

FRONT BRUSHGUARD



REAR BRUSHGUARD



DELUXE BRUSHGUARD

- Ideal for trail riding
- Provides maximum headlight and taillight protection
- High-performance design complements the vehicle's sporty styling
- Strong 1.25" (3.2 cm) diameter steel tube construction with a black powder-coat finish
- Installs easily in pre-drilled mounting locations
- Integrates with any winch or plow system
- Light mounting tabs on front

» 2878284 | Front

RZR® 570 MY 11-16, RZR® 800 MY 08-14, RZR® 4 MY 10-14, RZR® 900 MY 11-14, RZR® 900 4 MY 12-14

» 2878697 | Rear

RZR® 570 MY 12-16

BUMPERS & GUARDS CONTINUED



LOW PROFILE STEEL ROCK SLIDERS

- Plate steel construction, durable powder-coat finish
- Easy installation with expanded anchor mount
- No loss in ground clearance while protecting lower body panels

- » BLACK | 2879498-458
- » LIME SQUEEZE | 2881587-630
- » SPECTRA ORANGE | 2881587-446
- » INDY RED | 2879498-293
- » VELOCITY BLUE | 2881587-689
- » BRIGHT WHITE | 2879940-133

RZR® XP 1000 MY 14-16, RZR® 900 MY 15-16, RZR® S 900 MY 15-16, RZR® 900 XC MY 15-16, RZR® S 1000 MY 16, RZR® XP TURBO MY 16

4 - SEATER LOW PROFILE STEEL ROCK SLIDERS

- » BLACK | 2879940-458
- » LIME SQUEEZE | 2881593-630
- » SPECTRA ORANGE | 2881593-446
- » INDY RED | 2879940-293
- » VELOCITY BLUE | 2881593-689
- » BRIGHT WHITE | 2881593-133

RZR® XP 4 1000 MY 14-16, RZR® 4 900 MY 15-16

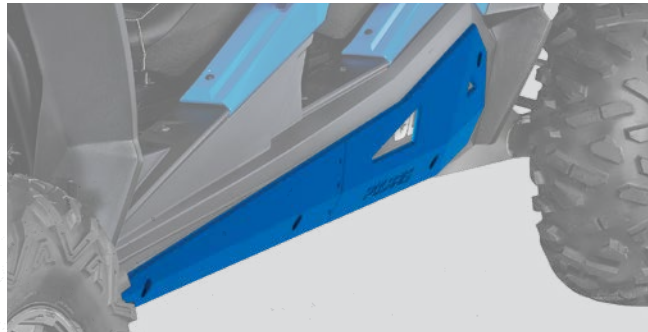

EXTREME KICK-OUT STEEL ROCK SLIDERS

- 1 3/4"-thick steel tube construction
- Powder-coat finish
- 5" kick-out protects side of vehicle from obstacles and provides a buffer between vehicle and trail obstacles
- Quick and easy install with expanded anchor mounting system

- » BLACK | 2879456-458
- » LIME SQUEEZE | 2881586-630
- » SPECTRA ORANGE | 2881586-446
- » INDY RED | 2881586-293
- » VELOCITY BLUE | 2881586-689
- » BRIGHT WHITE | 2881586-133

RZR® XP 1000 MY 14-16, RZR® 900 MY 15-16, RZR® S 900 MY 15-16, RZR® 900 XC MY 15-16, RZR® S 1000 MY 16, RZR® XP TURBO MY 16



MUDFLAPS

- Rigid injection-molded design to eliminate warping in high-heat conditions
- Designed to specifically integrate into front fender flares
- Keeps the front wheels from flipping mud into the cab

» 2879938

RZR® XP 1000 MY 14-16, RZR® XP 4 1000 MY 14-16, RZR® 4 900 MY 15-16, RZR® S 900 MY 15-16, RZR® 900 XC MY 15-16



FENDER FLARE KIT

- Enjoy extended coverage over your wide tires or widened suspension
- Fender Flares block mud and debris kicked up by the tires while riding
- Integrated styling makes these over-fenders look like stock bodywork

» 2879434

RZR® 900 MY 15-16



HMW SKID PLATE

- Additional vehicle underside protection that compliments stock skid plate
- Strong, durable and lightweight polyethylene construction
- Tough 3/8" thick design withstands the toughest impacts
- Custom contoured for a perfect fit to retain maximum ground clearance
- Includes all necessary mounting hardware and instructions

» 2881615

RZR® XP TURBO MY 16, RZR® XP 1000 MY 14-16

» 2880290

RZR® 1000 S MY 16, RZR® 900 MY 15-16, RZR® 900 S MY 15-16, RZR® 900 XC EDITION MY 15-16

» 2880291

RZR® 4 900 MY 15-16

» 2881725

RZR® XP 4 1000 MY 14-16



HMW FRONT A-ARM GUARDS

- Valuable, reliable protection for vital front suspension components of your machine
- Strong, durable, lightweight HMW (high-molecular weight) polyethylene construction helps protect against off-road impacts to protect the A-Arms
- Molded specifically for the RZR® front suspension for proper installation, a sure fit and low-profile presence

» 2879454

RZR® XP 1000 MY 14-16, RZR® XP TURBO MY 16

» 2880274

RZR® S 900 MY 15-16, RZR® S 1000 MY 16, RZR® 4 900 MY 15-16

» 2880170

RZR® 900 MY 15-16, RZR® 900 XC MY 15-16



REAR A-ARM GUARDS

» 2880171

RZR® S 900 MY 15-16, RZR® S 1000 MY 16, RZR® 4 900 MY 15-16

» 2880172

RZR® 900 MY 15-16, RZR® 900 XC MY 15-16



HMW REAR TRAILING ARM GUARDS

- Valuable, reliable protection for vital rear suspension components of your machine
- Strong, durable, lightweight HMW (high-molecular weight) polyethylene construction helps protect against off-road impacts to protect the Trailing Arms
- Molded specifically for the RZR® rear suspension for proper installation, a sure fit and low-profile presence

» 2879496

RZR® XP 1000 MY 14-16, RZR® XP 4 1000 MY 14-16, RZR® XP TURBO MY 16



PULL YOUR WEIGHT

No RZR® is complete without a winch. With heavy work applications and a backup plan for compromising conditions, a winch is the most versatile accessory you can buy.



HEAVY-DUTY PULLING POWER FOR YOUR JOB

DESIGNED FOR POLARIS® VEHICLES

- Integrated mounting locations for a perfect fit
- One number and one price for winch, remote, contactor, mount and wiring

HIGHEST QUALITY MATERIALS

- Steel spools and cut metal gears for greater durability
- Fully-sealed contactor, motor and drive train keep water out
- Corrosion-resistant finish withstands the elements

EXTENSIVE LAB AND FIELD TESTING

- Contactors, controls and winch assemblies tested 10,000+ cycles
- Rigorous performance testing in labs and in the field ensure your winch works when you need it most
- Strength testing ensures superior driveline strength



PRO PRO HEAVY DUTY SERIES

When world-class performance is called for, Polaris® PRO HD winches deliver. These winches combine heavy duty pulling power with premium features like auto-stop technology, synthetic rope for increased durability, aluminum hawse fairlead, and wireless remote control. Look to PRO HD winches for the best of the best.



When your ride leads to extreme conditions, turn to a Warn® winch, built exclusively for Polaris®. These workhorse winches are built with an unrivaled combination of premium components and are backed by the industry-leading Warn® Limited Lifetime warranty.



HD HEAVY DUTY SERIES

The HD line delivers industry-leading quality and durability with best-in-class value – powered by quality features including sealed motors and contactors, a roller fairlead, wired remote control and proven pulling power.

WINCH USES



Assist another vehicle that finds itself stuck



Moving heavy objects such as fallen trees

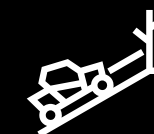

Allows the vehicle it's attached to remove itself from extremely difficult terrain/conditions



Essential part of plow system

WINCHES



PRO HD WINCHES

PRO PRO HEAVY DUTY SERIES

4500 LB. WINCH

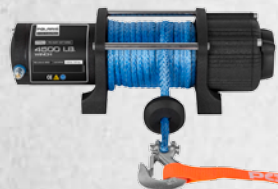

POLARIS® PRO HD 4500 LB. WINCH

- 4500 lbs of pulling capacity
- Auto-stop technology - ideal for snow plowing applications
- 50' of 6mm premium high strength synthetic rope
- High quality polished aluminum fairlead
- Integrated design to Polaris RZR®
- Fully sealed contactor, motor and drivetrain
- 6 gauge wiring maximizes current flow
- Low speed gearing for optimized plow control
- Cut metal gears for maximum durability
- Durable corrosion resistant finish
- Corded remote control with socket
- 1 year warranty

» 2881672

RZR XP TURBO MY16, RZR® XP 1000 MY14-16, RZR® XP4 1000 MY14-16, RZR® S 1000 MY16, RZR® S 900 MY15-16, RZR® 900 XC MY15-16, RZR® 900 4 MY15-16

Wiring kits required for installation, see fitment on page 29 for required part number.



HD WINCHES

HD HEAVY DUTY SERIES

3500 LB. WINCH

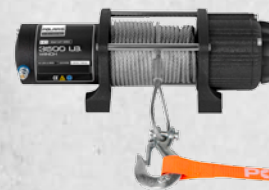

POLARIS® HD 3500 LB. WINCH

- 3500 lbs of pulling capacity
- Fully sealed contactor, motor and drivetrain
- 6 gauge wiring maximizes current flow
- 50' of 7/32" high strength steel cable
- Cut metal gears for maximum durability
- Durable corrosion resistant finish
- Low speed gearing for optimized plow control
- Corded remote control with socket
- 1 year warranty

» 2881671

RZR XP® TURBO MY16, RZR® XP 1000 MY14-16, RZR® XP4 1000 MY14-16, RZR® S 1000 MY16, RZR® S 900 MY15-16, RZR® 900 XC MY15-16, RZR® 900 4 MY15-16

Wiring kits required for installation, see fitment on page 29 for required part number.



WINCHES & PLOWS GO TOGETHER

The muscle to plow. Versatile Polaris® winches can be used to raise and lower plow blades. Choose the winch that meets your pulling and plowing needs. See pages 52-53 for plows.

PRO PRO HEAVY DUTY SERIES

PREMIUM FEATURES FOR HEAVY-DUTY PULLING POWER

AUTO-STOP TECHNOLOGY

- Stops winch at end of pull, prevents driveline stress
- Great for plowing, prevents overlifting
- Winch stops when collar on rope contacts fairlead

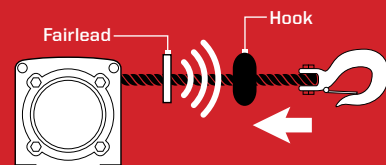

Winch stops when fairlead detects hook collar.

ALUMINUM FAIRLEAD

- Improves rope life, corrosion resistant

SYNTHETIC ROPE

- Superior flexibility, great strength, lightweight

HD HEAVY DUTY SERIES

HEAVY-DUTY PULLING POWER

- Cut steel gears for improved durability
- Steel spool can handle extreme loads
- 40% quieter - near-silent free spooling
- Sealed motor and drivetrain
- Low-voltage contactor
- Integrated wiring and mount plates ensure perfect fit

WARN® PROVANTAGE WINCHES



4500 LB. WINCH



WARN® PROVANTAGE 4500 LB. WINCH

- Manufactured by Warn® Industries, engineered specifically for Polaris® vehicles
- Premium power with 4,500-pounds of pulling capacity
- Full-sealing for maximum water resistance
- Patented roller disc brake for assured holding power
- Industry-leading Limited Lifetime Warranty, 3 year electrical
- Includes all components required for installation

» 2880789

RZR® XP 4 1000 MY 14-16, RZR® 4 900 MY 15-16
Requires wiring kit for installation

» 2880592

RZR® XP 1000 MY 14-16, RZR® 900 MY 15-16, RZR® S 900 MY 15-16
Requires wiring kit for installation

» 2880590

RZR® 900 MY 11-14, RZR® 900 4 MY 12-14

» 2880582

RZR® 570 MY 8-16, RZR® 800 MY 08-14



3500 LB. WINCH



WARN® PROVANTAGE 3500 LB. WINCH

- Powerful torque and legendary WARN® reliability, engineered for Polaris® vehicles
- Premium power with 3,500-pounds of pulling capacity
- Full-sealing for maximum water resistance
- Patented roller disc brake for assured holding power
- Industry-leading Limited Lifetime Warranty, 3 year electrical
- Includes all components required for installation

» 2880788

RZR® XP 4 1000 MY 14-16, RZR® 4 900 MY 15-16
Requires wiring kit for installation (2881551)

» 2880593

RZR® XP 1000 MY 14-16, RZR® 900 MY 15-16, RZR® S 900 MY 15-16, RZR® S 1000 MY 16, RZR® XC 900 MY 15-16, RZR® TURBO MY 16
Requires wiring kit for installations (2881551)

» 2880591

RZR® 900 MY 11-14, RZR® 900 4 MY 12-14

» 2880583

RZR® 570 MY 8-16, RZR® 800 MY 08-14

WINCH WIRING KIT

REQUIRED FOR POLARIS® PRO HD & POLARIS® HD WINCH INSTALLATION

- Necessary component to connect your accessory bus bar to the vehicle battery.
- Wires are cut to the precise length of your vehicle to minimize slack.

» 2879862

RZR® XP 1000 MY 14-15, RZR® 900 MY 15, RZR 900 S 15, 900 XC 15

» 2870055

RZR® XP 4 1000 MY 14-15, RZR® 4 900 MY 15

» 2871551

RZR® XP 1000 MY 16, RZR® 900 MY 16

» 2871646

RZR® XP 4 1000 MY 16, RZR® 4 900 MY 16, TURBO 16, S 1000 16, 900 S 16, 900 XC 16

WINCH ACCESSORIES

SYNTHETIC WINCH ROPE

- Polaris® winch ropes are designed to work with the Polaris® winch of the same rating. Always use the rope that is sized appropriately for your winch.

» 2879187

4500 LB. WINCH

» 2875791

3500 LB. WINCH

50 FT STEEL WINCH CABLE

- 50-feet of 3/16" high strength steel cable
- 3500 lb. rated

» 2878890

POLARIS® HD 3500 LB. WINCH



POLARIS® WIRELESS WINCH REMOTE

- Allows for remote operation of Polaris® HD winch
- Up to 50-foot range with LED indicator
- Provides for safer operation of winch in retrieval situations
- Direct plug and play operation

» 2879316

POLARIS® RZR WINCH KITS



POLARIS® PRO HD WINCH UPGRADE KIT

- Automatic winch stop prevents over-winding and frayed cables
- Corrosion-free, polished aluminum hawse fairlead
- Requires use of synthetic cable rope (not included)

» 2879149

Requires use of Winch Rope 2875791 (not included)
Use with 3500 lb. winch

EXTEND YOUR RIDE TIME

Stay out longer with the help of our powerful and technologically superior lighting systems, including our new attention-grabbing underbody accent lights. No other manufacturer can match the range, peripheral lighting and quality found in every Polaris Engineered™ lighting component. When you're looking to take your lighting to the next level, look no further than Polaris®.



SUPERIOR TECHNOLOGY

Polaris Engineered™ offers superior performance with technology to light your way. These lights use Polaris®-exclusive LED technology, angled reflectors and a proprietary shape for full-spread light projection so you can see more – *not only what's directly in front of you, but also what's in your periphery.*

- Traditional LED lights cast a beam of light straight in front of you where our new Polaris®-exclusive tilted reflector technology provides a wider range of vision
- IP67 rated; fully sealed - dust tight, fully submersible for up to one meter
- Durable integrated mounting locations on Polaris® machines
- 1 year warranty
- All light bars come pre-wired
- High grade CREE LEDs



Integrated 25/40 tilted outer lights and 10 degree center lights provide a more complete lighting experience. Technology only available on the 13" and 35" led light bars.

New reflector technology offers great peripheral and forward distance with over 750 feet of effective light

GREATER RANGE

Seeing is believing. The graphs and diagrams below show the illuminating power of Polaris® lights, and the lighting quality compared to stock headlights.

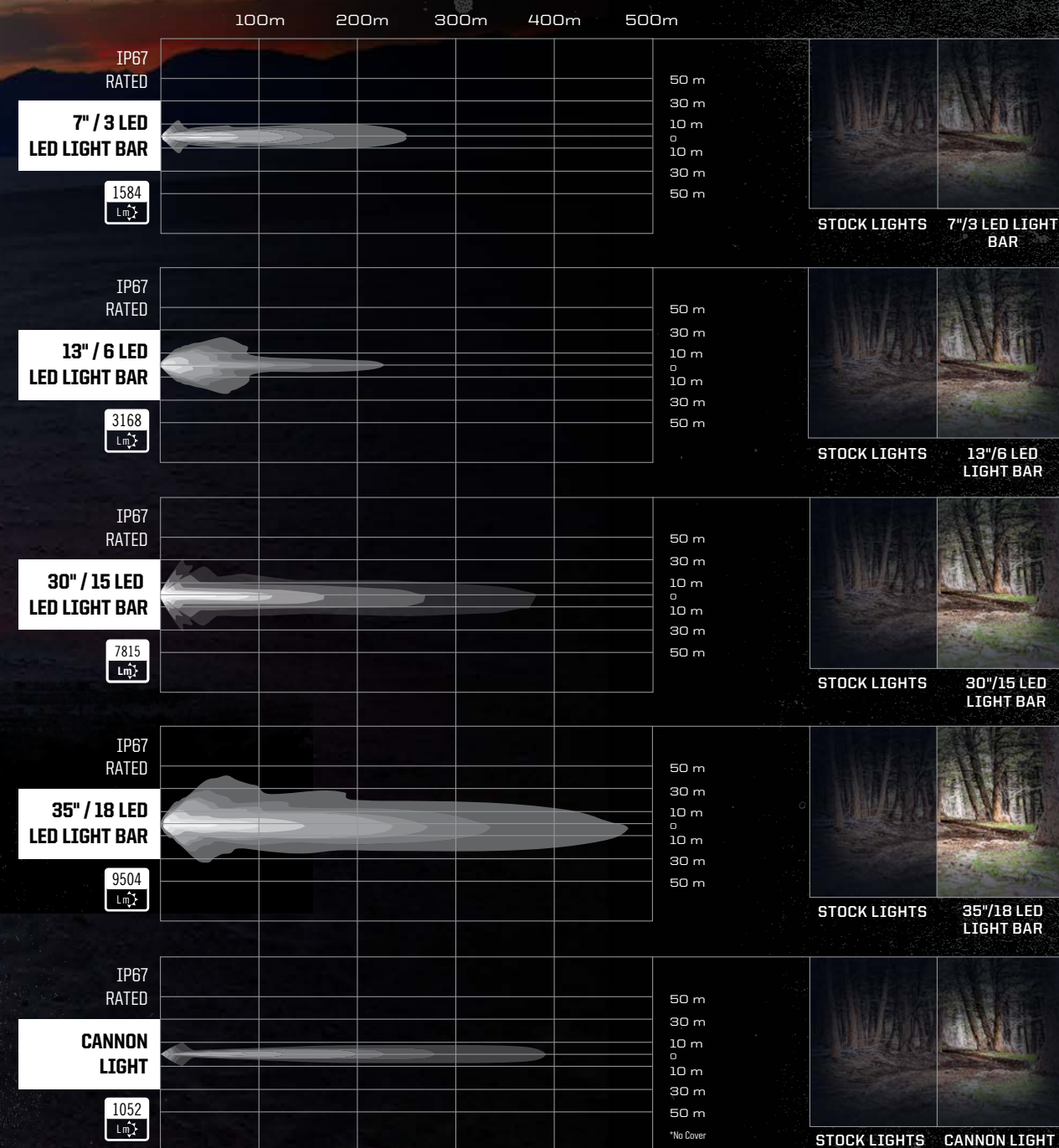

STOCK LIGHTS CANNON LIGHT



CANNON LIGHT / NEW

- 4" bullet style light produces 1052 Lumens of light
- Durable housing protects lights from rocks and debris
- Includes single 4" light, mount, Clear Euro Cover, Amber Euro Cover and Amber Spot Cover

» 2881471

ALL RZR® MODELS



Requires Busbar Harness (2881551) and Light Bar Harness (2879859). Under Roof Light Bar Mount (2881553) recommended. See harness chart on page 43 for specifics.



13" LED LIGHT BAR

- Convenient, versatile lighting that will enhance your riding experience
- 13" LED Light Bar elevates the vehicle's sporty, high-performance style
- Polaris® exclusive & manufactured by Vision X
- Installs quickly & easily into designated mounting locations and connects to vehicle's electrical system
- Delivers reliable performance & outstanding value
- Dust proof and waterproof up to one meter; tested to IP67 standards
- Premium 5 watt Cree XPG-2 LEDs
- 13.39" x 2.76" x 2.17" (34 cm x 7 cm x 5.5 cm)

» 2880530

ALL RZR® MODELS



Requires LED harness (sold separately). See harness chart on page 43 for specifics.



7" LED LIGHT BAR

- Convenient, versatile lighting that will enhance your riding experience
- 7" LED Light Bar elevates the vehicle's sporty, high-performance style
- Polaris® exclusive & manufactured by Vision X
- Installs quickly & easily into designated mounting locations and connects to vehicle's electrical system
- Delivers reliable performance & outstanding value
- Dust proof and waterproof up to one meter; tested to IP67 standards
- Premium 5 watt Cree XPG-2 LEDs
- 6.69" x 2.76" x 2.17" (17 cm x 7 cm x 5.5 cm)

» 2880624

ALL RZR® MODELS



Requires LED harness (sold separately). See harness chart on page 43 for specifics.



2" LED LIGHT

- 10-watt LED light
- Max output of 900 lumens
- Works great as work light or rear box light
- Weatherproof connectors with plug-and-play harness
- Die-cast aluminum housing with interlocking omni-link system and stainless steel hardware

» 2878715

ALL RZR® MODELS



Requires LED harness (sold separately). See harness chart on page 43 for specifics.



35" LED LIGHT BAR

- Convenient, versatile lighting that will enhance your riding experience
- 35" LED Light Bar elevates the vehicle's sporty, high-performance style
- Polaris® exclusive & manufactured by Vision X
- Installs quickly & easily into designated mounting locations and connects to vehicle's electrical system
- Delivers reliable performance & outstanding value
- Dust proof and waterproof up to one meter; tested to IP67 standards
- Premium 5 watt Cree XPG-2 LEDs
- 35.43" x 2.76" x 2.17" (90 cm x 7 cm x 5.5 cm)

» 2880527

ALL RZR® MODELS



Requires Busbar Harness (2881551) and Light Bar Harness (2879859). Under Roof Light Bar Mount (2881553) recommended.

See harness chart on page 43 for specifics. Installation instructions are included with the LED harness.



30" LED LIGHT BAR / NEW

- 30" light bar featuring 15 LED lights
- Produces 7815 Lumens of brilliant white light
- Slim, extruded aluminum housing for low profile mounting
- Powder-coated black finish

» 2881324

ALL RZR® MODELS

Requires Busbar Harness (2881551) and Light Bar Harness (2879859). Under Visor Light Bar Mount (2881203) recommended. See harness chart on page 43 for specifics.



30" UNDER ROOF LIGHTBAR MOUNT / NEW

- Mounts light bar under roof for protection and style
- Solid steel brackets and full adjustability

» 2881203

RZR XP® 1000 MY14-16, RZR XP® 4 1000 MY14-16, RZR XP® TURBO MY16, RZR® 1000 S MY16, RZR® 4 900 MY15-16, RZR® 900 MY14-16, RZR® 900 S MY15-16, RZR® 900 XC EDITION MY15-16. Includes mounts and hardware; light bar sold separately (2881324)

35" UNDER ROOF LIGHT BAR MOUNT / NEW

- Mounts light bar tight to cab roof for protection and style
- Solid steel brackets and full adjustability

» 2881553

RZR XP® 1000 MY14-16, RZR XP® 4 1000 MY14-16, RZR XP® TURBO MY16, RZR® 1000 S MY16, RZR® 4 900 MY15-16, RZR® 900 MY14-16, RZR® 900 S MY15-16, RZR® 900 XC EDITION MY15-16. Includes mounts and hardware; light bar sold separately (2880527)



ROOF-MOUNTED REAR BRAKE LIGHT

- LED high output for increased visibility
- Integrated mounting into accessory roofs
- Easy installation with vehicle wiring harness
- Material is durable, sealed, hard-plastic housing
- Mounts on rear edge of roof (sold separately)
- Includes brake light, wiring and installation instructions
- Features brake light and running light for increased visibility whenever the lights are on

» 2880702

RZR® XP 1000 MY 14-16, RZR® XP 4 1000 MY 14-16, RZR® 900 MY 15-16, RZR® S 900 MY 15-16, RZR® 900 XC MY 15-16, RZR® S 1000 MY16, RZR® XP TURBO MY 16, RZR® 4 900 MY 15-16



LED HEADLIGHT KIT

- Unique, innovative Polaris®-exclusive design and technology
- Replaces the stock headlights and provides brighter, more powerful lighting
- These lights use innovative angled reflectors instead of optics to cast a broader, brighter, more-effective light beam
- Provides greater visibility of your surroundings
- Makes your vehicle more visible to those nearby, especially other vehicle traffic

» 2880485

RZR® 900 MY 15-16, RZR® S 900 MY 15-16, RZR® 900 XC MY 15-16, RZR® 4 900 MY 15-16, RZR® S 1000 MY 16

LIGHTING CONTINUED



ACCENT LIGHTING KIT / NEW

- Set includes 4 LED pods
- Durable off-road ready construction that is both dust and water-resistant
- Features CREE LED for a long lasting brilliant light
- Easy to install in a variety of creative locations
- Control hub and complete instructions included

- » 2880500 | Red
 - » 2880506 | Blue
 - » 2881119 | White
- ALL RZR® MODELS

SINGLE ACCENT LIGHT / NEW

- Includes one LED available in blue, red or white pod
- Requires Accent Lighting Kit (2880500, 2880506, or 2881119)

- » 2880532 | Red
 - » 2880533 | Blue
 - » 2881176 | White
- ALL RZR® MODELS



UTILITY TAILLIGHT KIT / NEW

- Replaces stock taillights with integrated two in one lighting option
- Features bright white LED work lamp
- Made from durable and sealed hard plastic housing
- Easy installation into stock vehicle wiring harness

- » 2880156
RZR XP® 1000 MY15, RZR XP® 4 1000 MY14-16, RZR XP® TURBO MY16
- » 2880157
RZR® S 1000 MY16, RZR® 4 900 MY15, RZR® 900 MY14-15, RZR® 900 S MY15, RZR® 900 XC MY15

STORAGE & INTERIORS

ALWAYS ROOM FOR MORE

COOLER	CAPACITY	TIE DOWNS REQUIRED FOR SECURING TO MACHINE	LOCK & RIDE®	DIVIDER FOR SEPARATE DRY STORAGE	UV-RESISTANT	IGBC CERTIFIED BEAR RESISTANT	BUILT-IN DRAIN
LOCK & RIDE® COOLER BOX	48 qt.		X		X		X
LOCK & RIDE® COOLER BOX	51 qt.		X		X		X
POLARIS® NORTHSTAR® COOLER	60 qt.	X		X	X	X	X
POLARIS® NORTHSTAR® COOLER	30 qt.	X		X	X	X	X



LOCK & RIDE® COOLER BOX / NEW

- Strong one-piece roto-molded construction for extreme durability
- Lid latches securely in place with rubber lockable latches to protect cargo
- Lid has heavy-duty hinges & a weatherproof seal to block moisture & dust
- Extra thick walls with pressure-injected insulation for maximum ice retention
- Chest can keep food & beverages cool for 48 hours or longer, depending on conditions
- Cargo box is UV-resistant so it won't fade in the sun
- Lock & Ride®: Installs quickly & easily
- Integrated grab handles make it easy to carry box to & from your RZR®

- » 2881556 | 51 qt.
RZR® 1000 S MY16, RZR® 4 900 MY15-16, RZR® 900 MY14-16, RZR® 900 S MY15-16, RZR® 900 XC EDITION MY15-16
- » 2881555 | 48 qt.
RZR XP® 1000 MY14-16, RZR XP® 4 1000 MY14-16, RZR XP® TURBO MY16



POLARIS® NORTHSTAR® COOLER / NEW

- Thick 2-inch insulation barrier delivers premium, long-lasting cooling
- Integrated tie-down cleats enable attachment to any off-road vehicle, boat or truck
- UV resistant polyethylene construction
- Internal tray and dividers allows for dual dry storage solutions
- Available in both 30-quart and 60-quart sizes

- » 2881259 | 60 qt.
ALL RZR® MODELS
- » 2881315 | 30 qt.
ALL RZR® MODELS



FITS TWO HELMETS AND ROOM FOR MORE

LOCK & RIDE® OGIO® CARGO BAG / NEW

- Large storage capacity - 23.5" L x 22.75" W x 15" H (6100 cubic inches/100 liters)
- Constructed from water resistant Tarpalline material
- Heavy-duty U-shaped zipper opening and oversized buckles
- Lock & Ride® mounting technology for easy-on and easy-off
- MOLLE lash loops for additional mounting options.
- Additional Roll Top Side Bag also Included.

- » 2881204
RZR XP® 1000 MY14-16, RZR XP® 4 1000 MY14-16, RZR XP® TURBO MY16, RZR® 1000 S MY16, RZR® 4 900 MY15-16, RZR® 900 MY14-16, RZR® 900 S MY15-16, RZR® 900 XC EDITION MY15-16

OGIO® CARGO BAG ADD ON / NEW

- » 2881549
RZR XP® 1000 MY14-16, RZR XP® 4 1000 MY14-16, RZR XP® TURBO MY16, RZR® 1000 S MY16, RZR® 4 900 MY15-16, RZR® 900 MY14-16, RZR® 900 S MY15-16, RZR® 900 XC EDITION MY15-16

STORAGE & INTERIORS CONTINUED



LOCK & RIDE

LOCK & RIDE® CARGO BOX / NEW

- Integrated rear cargo box touting 4,000 cubic-inches (65-Liters) of storage
- Secure latching lid with taunt rubber strap tie-downs
- Lightweight design integrates seamlessly with RZR® rear cargo bed
- Includes all mounting hardware for complete installation
- Designed with a flat top for additional top mounted cargo capacity

» 2881193

RZR® XP 1000 MY 14-16, RZR® XP 4 1000 MY 14-16, RZR® XP TURBO MY 16, RZR® 1000 S MY 16, RZR® 4 900 MY 15-16, RZR® 900 MY 14-16, RZR® 900 S MY 15-16, RZR® 900 XC EDITION MY 15-16



LOCK & RIDE

LOCK & RIDE® CARGO BOX

- Strong one-piece roto-molded construction for extreme durability
- Lid latches securely in place with rubber lockable latches to protect cargo
- Lid has heavy-duty hinges and a weatherproof seal to block moisture and dust
- Lock & Ride®. Installs quickly and easily
- Integrated grab handles make it easy to carry box to and from your RZR®

» 2876439-070

RZR® 570 MY 12-16, RZR® 800 MY 08-14, RZR® S MY 09-14, RZR® 4 MY 10-14



XL STORAGE BOX / NEW

- Extra large storage capacity box with lid secured by four rubber clasps
- Designed to mount to several Polaris RANGER®, Sportsman®, and RZR® 900 vehicles
- Includes internal dividers and reversible lid for additional tie-down points
- Use with internal storage bags to organize your gear
- Requires vehicle specific mounting kit

» 2881128-070

RZR® 1000 S MY 16, RZR® 4 900 MY 15-16, RZR® 900 MY 14-16, RZR® 900 S MY 15-16, RZR® 900 XC MY 15-16

Insert up to 3 XL accessory bags in box for additional organized storage



XL SOFT SIDE COOLER / NEW

- Designed to fit inside the Lock & Ride® XL Storage Box (2881128-070)
- Held securely in place by internal Lock & Ride® XL Storage Box one-third divider
- Durable 600 Denier PVC shell and insulated lining keeps items cool and protected
- Shoulder strap and convenient zipper top allows for standalone use

» 2881428



XL TRAIL BAG / NEW

- Delivers convenient and easily accessible storage solutions
- High-strength 600 Denier PVC outer shell features multiple zipper access options
- Durable 600 Denier PVC shell and insulated lining keeps items cool and protected
- Held securely in place by internal Lock & Ride® XL Storage Box one-third divider

» 2881130



XL TOOL BAG / NEW

- Semi-rigid design provides strength and shape for larger items
- Large zipper access and multiple pocket storage in one bag
- Designed to fit inside the Lock & Ride® XL Storage Box (2881128-070) or standalone
- Held securely in place by internal Lock & Ride® XL Storage Box one-third divider

» 2881129



LOCK & RIDE® D-RINGS

- Lock & Ride® technology for easy installation and removal
- Large D-rings provide ideal tie-down points

» 2881544

ALL RZR® MODELS



TIE-DOWN RATCHET STRAPS

- » 2859047-01 | Red
- » 2859047-02 | Black



TIE-DOWN STRAPS

- » 2871182 | Black



ON A LONG RIDE,

"MY RAIN GEAR IS THE FIRST THING TO BE PACKED, THEN WATER, TOILET PAPER, MY GLOVES, EXTRA CONTACTS AND SOLUTION. I LOVE MY LOCK & RIDE® BOX, IT HOLDS ALL MY STUFF!"

– LISA P., POLARIS OWNER



UPPER DOOR STORAGE BAG

- Installs conveniently on inside of door, putting storage within easy reach
- Storage bags mount easily and provide zippered storage spaces for small items
- Bags are Polaris®-branded

» 2880612

RZR® XP 1000 MY 14-16, RZR® S 900 MY 15-16, RZR® 900 XC MY 15-16, RZR® 1000 S MY 16, RZR® XP 4 1000 MY 14-16, RZR® 4 900 MY 15-16, RZR® XP TURBO MY 16



LOWER DOOR STORAGE BAG

- Installs conveniently on inside of accessory lower door, putting storage within easy reach
- Storage bags mount easily and provide zippered storage spaces for small items
- Bags are RZR®-branded

» 2880613

RZR® XP 1000 MY 14-16, RZR® S 900 MY 15-16, RZR® 900 XC MY 15-16, RZR® 1000 S MY 16, RZR® XP 4 1000 MY 14-16, RZR® 4 900 MY 15-16, RZR® XP TURBO MY 16

2880613 requires lower door inserts (2879509, sold separately)

» 2880616

RZR® 900 MY 15-16

2880616 requires lower door inserts (2880207, sold separately)



SIDE BAG

- Polyester fabric with carbon-fiber look
- Dust resistant zippers with access from both inside and outside the vehicle
- Easy install with Velcro® attachments
- Great for storing tools with an integrated elastic tool strap

» 2879518

RZR® XP 1000 MY 14-16, RZR® XP 4 1000 MY 14-16, RZR® XP TURBO MY 16



SHOULDER STORAGE BAG

- Fits between seats, attaches with clips
- Interior mesh pockets store small items
- Easy to install, remove and take along
- Perfect for storing your GPS, gloves, cell phone and more

» 2878352

RZR® 570 MY 12-16, RZR® 800 MY 08-14, RZR® S 4 MY 10-14, RZR® 900 MY 11-14, RZR® 900 4 MY 12-14



OVERHEAD MAP BAG

- Storage bag for maps, GPS, other small items
- Attaches to cab frame with Velcro® straps
- Easy to install, remove and take along

» 2878351

RZR® 570 MY 12-16, RZR® 800 MY 08-14, RZR® S MY 09-14, RZR® 900 MY 11-14



OVERHEAD BAG

- Polyester fabric with carbon fiber look
- Multiple pockets, weather-proof zippers and waterproof compartment for valuables, phone or audio devices
- Easy install with Velcro attachments and fiberglass rods for reinforcement

» 2879516

RZR® XP 1000 MY 14-16, RZR® S 900 MY 15-16, RZR® 900 XC MY 15-16, RZR® S 1000 MY 16, RZR® XP TURBO MY 16, RZR® XP 4 1000 MY 14-16, RZR® 4 900 MY 15-16



GUN BOOT MOUNT

- Safely and securely carry firearm scabbards by attaching them to the Cab Frame Extension Upper Section (Scabbards and Cab Frame Extension sold separately)
- Gun Scabbard Mount installs easily and holds one or two scabbards
- Strong, durable, black powder-coated scabbard mount coordinates with the style of the extension and vehicle framework

» 2880313

RZR® 900 MY 15-16, RZR® S 900 MY 15-16, RZR® 900 XC MY 15-16, RZR® 4 900 MY 15-16, RZR® S 1000 MY 16



POLARIS® GUN BOOT BY KOLPIN®

- High-impact gun boot with interior padding
- Dust-proof and water-resistant shell
- Accommodates almost all rifles and shotguns with larger scopes
- Mount is required and sold separately (2880313) to attach your gun boot to your vehicle

» 2872677-419 | Mossy Oak®

ALL RZR® MODELS

» 2872677 | Black

ALL RZR® MODELS

STORAGE & INTERIORS CONTINUED



SPARE TIRE CARRIER

- Material is steel
- Mounts on the rear cab frame in under 5 minutes using four provided clamps
- Includes RZR® Tire Holder and mounting hardware
- Easily pivots to access cargo area

» 2879464

RZR® XP 1000 MY 14-16, RZR® XP 4 1000 MY 14-16, RZR® XP TURBO MY 16

» 2880148

RZR® 900 MY 15-16, RZR® S 900 MY 15-16, RZR® 900 XC MY 15-16, RZR® 4 900 MY 15-16, RZR® S 1000 MY 16

2880148 requires Upper Cab Frame Extension (2880411) and either Lower Cab Frame Extension (2880412) or Deluxe Rear Bumper (2880164) with Bumper Adapter (2880165) (all sold separately)



RIDE & REPAIR ESSENTIALS KIT / NEW

- 12-volt DC portable air compressor
- Tire repair kit with 6 plugs
- Basic first-aid kit with bandages, scissors, safety pins and more
- 12-volt jumper cables
- Duct tape - 300mm x 1 roll
- Zip ties - 150mm length
- Electrical tape
- Ratchet strap - 50mm
- Microfiber cloth
- Carry bag

» 2881207

ALL RZR® MODELS



OFF-ROAD JACK KIT / NEW

- Total vertical lift of 33-inches
- Cast aluminum brackets secures jack to roll cage or rear bumper
- Solid-steel constructions with black powder-coat finish
- Includes jack, mount, instructions and all mounting hardware

» 2881201

ALL RZR® MODELS



FIRE EXTINGUISHER MOUNT / NEW

- Tough Powder Coated aluminum construction
- Designed to mount directly to over-structure frame
- Features quick single pin release for instant access
- Low profile design utilizes minimum space
- Accepts most standard 3-inch diameter fire extinguisher (not included)

» 2881200

ALL RZR® MODELS



FOLDING SIDE MIRRORS / NEW

- Kit includes left and right mirrors with mounting brackets and hardware
- Hinges feature breakaway design for tight trail conditions and easy trailering
- Stylish design with adjustable inner mirror integrates with vehicle
- Mounts directly to factory roll cage at the bolt location, works with windshields and doors

» 2881198

RZR® XP 1000 MY 14-16, RZR® XP 4 1000 MY 14-16, RZR® 1000 S MY 16, RZR® 4 900 MY 15-16, RZR® 900 MY 14-16, RZR® 900 S MY 15-16, RZR® 900 XC MY 15-16



WIDE-ANGLE REAR VIEW MIRROR / NEW

- Stamped steel frame and backing plate with large 2.5"x14" convex mirror
- Quick glance, wide-angle viewing for maximum visibility
- Easy over-structure installation with stamped steel mounts
- Up to 10-degrees of adjustability to adapt to different sized riders

» 2881199

ALL RZR® MODELS



CONVEX REAR VIEW MIRROR

- Installs easily: Mount bolts into your choice of pre-designated mounting locations on vehicle frame
- Mirror attaches to mount and is adjustable
- Convex design provides broad, expanded view of what's behind or alongside the vehicle
- Can be used with all roofs, soft tops and windshields
- Scratch resistant glass mirror lens

» 2880531

ALL RZR® MODELS



REAR VIEW MIRROR

- Convex design delivers wide rear view
- Works with all roofs, soft tops and windshields

» 2877945

ALL RZR® MODELS



RZR® HIGH FLOW MESH PERFORMANCE SEAT / NEW

- Unique mesh material covering delivers added airflow to seat bottom and back
- Water will not puddle on seat
- Ideal for hot, humid or damp riding conditions
- Easy clean material wrapped around solid steel frame construction
- Includes complete seat and installation kit
- Add a Click 6 Harness for additional safety minded performance
- 10 lbs lighter than stock seats

» 2881469

RZR® XP 1000 MY 14-16, RZR® XP 4 1000 MY 14-16, RZR® XP TURBO MY 16, RZR® 1000 S MY 16, RZR® 4 900 MY 15-16, RZR® 900 MY 14-16, RZR® 900 S MY 15-16, RZR® 900 XC EDITION MY 15-16



HEATED STEERING WHEEL / NEW

- Heated steering wheel with Rotational Power Device for a clean installation
- Dash mounted on/off rocker switch control
- Polaris® branded center cap
- Includes all necessary hardware, wiring on connections for clean and easy install

» 2881573

ALL RANGER® FULL SIZE AND 2 SEAT / 4 SEAT Dash mounted rocker switch



CLICK-6 HARNESSSES

- Racing-quality premium construction for the greatest security & protection
- Six straps hold a driver securely in place in all riding conditions
- Each strap is individually adjustable for the best custom fit
- Dual shoulder straps have camlock mechanism to hold driver in place which act like a seat belt to hold the driver's hips securely on the seat
- One-click, quick-release buckle releases straps, allows easy egress
- Shoulder straps feature RZR® branding

» 2879854 | DRIVER SIDE

RZR® S 900 MY 15-16, RZR® 900 MY 15-16, RZR® 900 XC MY 15-16, RZR® XP 1000 MY 14-16, RZR® S 1000 MY 16, RZR® TURBO MY 16

» 2880470 | PASSENGER SIDE

RZR® S 900 MY 15-16, RZR® 900 MY 15-16, RZR® 900 XC MY 15-16, RZR® XP 1000 MY 14-16, RZR® S 1000 MY 16, RZR® TURBO MY 16



SEAT SLIDER

- Strong, durable, proven reliable construction
- Seat mounts securely to Seat Slider, then can be moved forward or backward
- Allows rider to position the seat in the ideal location for optimized comfort & control
- Installs easily: Seat Slider bolts solidly to floor of vehicle, seat bolts to slider
- Works with stock or Polaris® Performance Seats
- Sold individually; purchase two to provide driver & passenger with seat adjustability

» 2879460

RZR® XP 1000 MY 14-16, RZR® XP 4 1000 MY 14-16, RZR® XP TURBO MY 16, RZR® 1000 S MY 16, RZR® 4 900 MY 15-16, RZR® 900 MY 14-16, RZR® 900 S MY 15-16, RZR® 900 XC EDITION MY 15-16

» 2877390

RZR® XP 900 MY 11-13, RZR® 170 MY 12, RZR® 4 800 MY 10-14, RZR® 4 900 MY 14, RZR® 570 MY 12-16, RZR® 800 MY 08-14, RZR® 900 MY 14, RZR® S 800 MY 09-14



ALL WEATHER FLOOR MATS

- Strong, durable molded plastic construction
- Mats are custom-molded to fit precisely on the floor of each applicable RZR® model
- Mats keep the vehicle floor clean from dirt, mud, snow, debris and moisture
- Mats can be easily removed for cleaning; sprayed clean or hand-washed
- Mat design provides riders' feet with enhanced traction for the best foothold on the floor while riding

» 2880414 | Front

RZR® S 900 MY 15-16, RZR® 900 MY 15-16, RZR® 900 XC MY 15-16, RZR® XP 1000 MY 14-16, RZR® S 1000 MY 16, RZR® TURBO MY 16

» 2880415

RZR® XP 4 1000 MY 14-16, RZR® 4 900 MY 15-16



SEATBELT PAD

- Added comfort for long rides
- Easy Velcro® attachment

» 2880161 | Black Vinyl

ALL RZR® MODELS

» 2880160 | Carbon Neoprene

ALL RZR® MODELS



RZR® WHIP FLAG

- High visibility 8' x 21" red flag with RZR logo
- Durable 3/8" fiberglass rod with silicon rubber stoppers
- Includes zinc plated steel mounting plate and mounting hardware

» 2881468

ALL RZR® MODELS



BILLET CLAMPS

- Premium look and secure, reliable performance
- Sold individually

» 2878907



BED D-RINGS

- Creates additional tie-down points in box
- Makes securing cargo quick and easy
- Kit includes 4 D-rings and hardware

» 2877460

ALL RZR® MODELS



LOCK & RIDE® FLAG MOUNT

- Expansion anchor allows easy on/off
- Holds whip flag, required in some areas

» 2877502

ALL RZR® MODELS

AUDIO



WHAT DO YOU LISTEN TO WHEN YOU'RE RIDING?

"SOME CLASSIC ROCK WHEN TEARING UP THE DUNES, AND COUNTRY MUSIC WHEN CRUISING THE BEACH WITH THE FAMILY."

— ADAM G., POLARIS® OWNER



CRANK IT UP

Blast your tunes loud and clear while you're out riding. Build your own custom sound system with Polaris Engineered™ audio equipment.



EXTREME AUDIO PODS / NEW

- Two 8" coaxial speakers with 1" titanium tweeters in weatherproof enclosures
- Self-amplified 200-watt per speaker output
- Backlit LED illumination selectable between red and blue
- Rotating, low-profile, rubber isolated mounts
- Durable black satin finish
- Includes waterproof connections
- Requires audio harness, head unit or Bluetooth® Remote (2881470)

» 2881227

ALL RZR® MODELS

See Harness charts on pages 43-44 for required harnesses
AVAILABLE IN SEPTEMBER 2015

NEW SOUND BAR 8 AUDIO SYSTEM



Large buttons provide easy control, even with gloves on

Booming sound provided by 6 midrange/midbass speakers and 2 tweeters



SOUND BAR 8 / NEW

- Six midrange/midbass speaker and two dedicated tweeters
- Integrated, self-powered amplifier for easy installation
- Bluetooth® or wired audio input with variable output
- Large easy-to-use external controls
- Aluminum, black finish housing with low profile, clamp-on mounts
- Includes mounts, audio bar, waterproof connections and instructions
- Excellent audio building block when paired with sub woofer and audio pods
- Requires Audio Harness (2879865)

» 2881465

ALL RZR® MODELS

See Harness charts on pages 43-44 for required harnesses
AVAILABLE IN SEPTEMBER 2015



SOUND BAR 4 / NEW

- Dual midrange/midbass speaker and two dedicated tweeters
- Integrated self-powered amplifier for easy installation
- Bluetooth® or wired audio input with variable output
- Large, easy to use external controls.
- Aluminum, black finish housing with low profile clamp-on mounts
- Includes mounts, audio bar, waterproof connections and instructions
- Excellent audio building block when paired with sub woofer and audio pods
- Requires Audio Harness (2879865)

» 2881230

ALL RZR® MODELS

See Harness charts on pages 43-44 for required harnesses
AVAILABLE IN SEPTEMBER 2015



WATERPROOF BLUETOOTH® AUDIO

- MBQuart Audio Technology
- Kit includes four mounting configurations
- Self contained wireless audio unit provides a rider with rich, powerful, high-quality audio
- Mounts easily to the handlebars, roll cage or fits in your dashboard storage area
- IPX4 rated for water and dust resistance
- Simple controls on top of unit adjust volume and function
- Audio unit has Bluetooth® connectivity with voice prompts and voice commands (voice commands on iOS only)
- Internal LiPo rechargeable battery provides 12 hours of music between charges
- Unit can be easily removed from your ATV between rides for recharging and for use in other applications

» 2880458

See Harness charts on pages 43-44 for required harnesses
ALL RZR® MODELS



BLUETOOTH® AUDIO REMOTE / NEW

- Bluetooth® technology allows you to play music through speakers of choice
- Mount anywhere and control music with easy to use push-button pad
- Keep your iPod®, smart phone or tablet stowed way safely
- Ideal addition to accessory Extreme Audio Pods (2881227)

» 2881470

ALL RZR® MODELS

See Harness charts on pages 43-44 for required harnesses
AVAILABLE IN SEPTEMBER 2015



MTX® COMPLETE AUDIO SYSTEM

- Includes: Overhead Audio Pod, Rear Two Speaker Add-On and Powered Subwoofer (A-C pictured on the right)
- Waterproof marine grade construction Oversized buttons and back-lit display for easy operation
- Two fully sealed storage compartment for phone storage
- 2 directional high output tweeters
- USB charging and blue tooth connectivity capability
- Mounts on cab frame in designated mounting positions for easy installation

▶ **2879826**

RZR® XP 1000 MY14-16, RZR® XP 1000 HIGH LIFTER EDITION MY16, RZR® XP 4 1000 MY14-16, RZR® XP TURBO MY16, RZR® XP 1000 FOX® EDITION MY15, RZR® 1000 S MY16, RZR® 4 900 MY15-16, RZR® 900 MY15-16, RZR® 900 MY14-16, RZR® 900 FOX® EDITION MY16, RZR® 900 S MY15-16, RZR® 900 S MY15-16, RZR® 900 XC EDITION MY15-16

XP4 requires XP4 Audio Extension Harness (2879941) for installation.

A. MTX® OVERHEAD AUDIO POD

- Fully-sealed, injection-molded enclosure with marine-grade components
- 50Wx2 power
- Fully-sealed dry storage locker
- Mounts on cab frame in designated mounting positions
- Bluetooth® connectivity
- Full audio display
- Includes Overhead Audio Pod, wiring, mounting hardware and instructions
- Less than 15-minute, easy installation

▶ **2879459**

RZR® XP 1000 MY 14-16, RZR® 900 MY 15-16, RZR® S 900 MY 15-16, RZR® 900 XC MY 15-16, RZR® S 1000 MY16, RZR® XP TURBO MY 16

B. MTX® POWERED SUBWOOFER

- Marine-grade, fully sealed, rotationally molded plastic enclosure offers deeper molded housing for improved bass output and audio quality
- High-output speaker for elevated volume without compromising audio quality
- Subwoofer mounts under vehicle dash/glove box and connects to Overhead Audio Pod (sold separately 2879459)
- 200W digital low-draw amp

▶ **2880502**

RZR® XP 1000 MY 14-16, RZR® 900 MY 15-16, RZR® S 900 MY 15-16, RZR® 900 XC MY 15-16, RZR® S 1000 MY16, RZR® XP TURBO MY 16

C. REAR TWO SPEAKER ADD-ON

- Fully-sealed, injection-molded enclosure with marine-grade components
- Fully-sealed dry storage locker
- Speakers plug directly into Overhead Audio Pod (sold separately)
- Includes Two Speaker Add-On, wiring, mounting hardware and instructions
- Less than 15-minute, easy installation

▶ **2879514**

RZR® XP 1000 MY 14-16, RZR® 900 MY 15-16, RZR® S 900 MY 15-16, RZR® 900 XC MY 15-16, RZR® S 1000 MY16, RZR® XP TURBO MY 16

Requires XP4 Audio Extension Harness (2879941) for installation.

RZR® XP 4 AUDIO EXTENSION CABLE (NOT SHOWN)

- Connects Two Speaker Add-On to MTX® overhead audio pod

▶ **2879941**

RZR® XP 4 1000 MY 14-16, RZR® 4 900 MY 15-16



PREMIUM AUDIO ROOF

- The most versatile single accessory ever offered, providing protection, comfort, style, storage, lighting, and premium audio
- Strong, durable black molded-poly roof provides shade and reliable overhead protection
- Roof is styled to complement the sporty look of the RZR®
- Roof mounts easily on the vehicle frame in designated locations using provided hardware
- Audio system is completely integrated under the roof
- Audio head unit positioned at front of roof with controls within reach of driver and passenger
- Audio is delivered through four powerful 6x9 speakers
- Accessory subwoofer (2880502; sold separately) can be mounted under the dash for enhanced output
- Multi-angle LED Light Bars are integrated in recesses at the front and rear of the roof
- Front of roof houses three light bars
- Rear of roof has taillights and powerful LED floodlight
- Under-roof storage pod is foam padded to safely secure small items

▶ **2880417**

RZR® XP 1000 MY 14-16, RZR® 900 MY 15-16, RZR® S 900 MY 15-16, RZR® 900 XC MY 15-16, RZR® S 1000 MY16, RZR® XP TURBO MY 16



GLOVE-FRIENDLY CONTROLS



SPEAKER SET UP WITH TABLET STORAGE BOX



REAR TAIL LIGHTS AND UTILITY LIGHT

STEP 1 DETERMINE YOUR WIRING NEEDS

AUDIO	LIGHTING				
	NO LIGHTING	ROOF/VISOR LIGHT	1 REAR LIGHT OR 1 FRONT LIGHT + 1 REAR LIGHT	BUMPER LIGHT	2 BUMPER LIGHTS
•SOUNDBAR 4 OR 8 SPEAKER (2881230/2881465) •MTX REAR TWO SPEAKER ADD-ON (2879514) •EXTREME AUDIO PODS (2881227)	•2881617 •2881648 •2881651 •2881652	•2881617 •2881648 •2881651 •2881652	•2881617 •2881648 •2881651 •2881652	•2881617 •2881648 •2881651 •2881652 •2879859	•2881617 •2881648 •2881651 •2881652 •2879859 •2879860
AUDIO SIGNAL SOURCE: MTX OVERHEAD AUDIO POD (2879459) *USE OF MTX PODS WITH MB QUART AUDIO PODS REQUIRES MTX ADAPTER HARNESS 2881648					
•MTX OVERHEAD AUDIO POD (2879459)*	•2879459	•2879459 •2879859 •2879860	•2879459 •2879859 •2879860	•2879459 •(2) 2879859 •2879860	•2879459 •(2) 2879859 •(2) 2879860
•MTX OVERHEAD AUDIO POD (2879459)* •EXTREME AUDIO PODS (2881227)	•2879459 •2881617 •2881648 •2881651 •2881652	•2879459 •2881617 •2881648 •2881651 •2881652	•2879459 •2881617 •2881648 •2881651 •2881652	•2879459 •2881617 •2881648 •2881651 •2881652 •2879859	•2879459 •2881617 •2881648 •2881651 •2881652 •2879859 •2879860
•MTX OVERHEAD AUDIO POD (2879459)* •(2) EXTREME AUDIO PODS (2881227)	•2879459 •2881617 •2881648 •(2) 2881651 •2881652	•2879459 •2881617 •2881648 •2881651 •2881652	•2879459 •2881617 •2881648 •(2) 2881651 •2881652	•2879459 •2881617 •2881648 •(2) 2881651 •2881652 •2879859	•2879459 •2881617 •2881648 •(2) 2881651 •2881652 •2879859 •2879860
•MTX OVERHEAD AUDIO POD (2879459)* •MTX REAR TWO SPEAKER ADD-ON (2879514)	Harnesses supplied with below kits. •2879459 •2879514	•2879859	•2879859 •2879860	•(2) 2879859 •2879860	•(2) 2879859 •(2) 2879860
•MTX COMPLETE AUDIO SYSTEM (2879826)*	Harnesses supplied with below kit	•2879859	•2879859 •2879860	•(2) 2879859 •2879860	•(2) 2879859 •(2) 2879860
•MTX OVERHEAD AUDIO POD (2879459)* •MTX REAR TWO SPEAKER ADD-ON (2879514) •EXTREME AUDIO PODS (2881227)	•2881617 •2881648 •2881651 •2881652	•2881617 •2881648 •2881651 •2881652	•2881617 •2881648 •2881651 •2881652	•2881617 •2881648 •2881651 •2881652 •2879859	•2881617 •2881648 •2881651 •2881652 •2879859 •2879860
AUDIO SIGNAL SOURCE: BLUETOOTH® CONTROLLER OR PIDD (2881470/2881554) *USE OF PIDD REQUIRES PIDD ACCESSORY HARNESS 2881649					
•BLUETOOTH® CONTROLLER OR PIDD (2881470/2881554*) •EXTREME AUDIO PODS (2881227)	•2881617 •(2) 2881652	•2881617 •(2) 2881652	•2881617 •(2) 2881652	•2881617 •(2) 2881652 •2879859	•2881617 •(2) 2881652 •2879859 •2879860
•BLUETOOTH® CONTROLLER OR PIDD (2881470/2881554*) •(2) EXTREME AUDIO PODS (2881227)	•2881617 •(2) 2881651 •(2) 2881652	•2881617 •(2) 2881651 •(2) 2881652	•2881617 •(2) 2881651 •(2) 2881652	•2881617 •(2) 2881651 •(2) 2881652 •2879859	•2881617 •(2) 2881651 •(2) 2881652 •2879859 •2879860
•BLUETOOTH® CONTROLLER OR PIDD (2881470/2881554*) •MTX REAR TWO SPEAKER ADD-ON (2879514)	•2881617 •2881648 •2881652	•2881617 •2881648 •2881652	•2881617 •2881648 •2881652	•2881617 •2881648 •2881652 •2879859	•2881617 •2881648 •2881652 •2879859 •2879860
•BLUETOOTH® CONTROLLER OR PIDD (2881470/2881554*) •MTX REAR TWO SPEAKER ADD-ON (2879514) •EXTREME AUDIO PODS (2881227)	•2881617 •2881648 •(2) 2881651 •(2) 2881652	•2881617 •2881648 •(2) 2881651 •(2) 2881652	•2881617 •2881648 •(2) 2881651 •(2) 2881652	•2881617 •2881648 •(2) 2881651 •(2) 2881652 •2879859	•2881617 •2881648 •(2) 2881651 •(2) 2881652 •2879859 •2879860

*IF YOU HAVE MTX POWERED SUBWOOFER (2880502) ALSO NEED TO ADD SUBWOOFER HARNESS (2881647), IF YOU HAVE 2+ AUDIO ACCESSORIES WILL ALSO NEED TO ADD Y-HARNESS (2881651)

*ALL COMBINATIONS ALSO REQUIRE A BUSBAR HARNESS, REFER TO PAGE 44 FOR BUSBAR PART NUMBERS AND VEHICLE FITMENT

FOR A COMPLETE GUIDE OF ALL OUR AUDIO AND LIGHTING HARNESSSES, PLEASE VISIT POLARIS.COM

AUDIO & LIGHTING HARNESSES CONTINUED

STEP 2 UNDERSTANDING YOUR ROUTING PATH

AUDIO HARNESSES

HARNESS	HARNESS P/N	FUNCTION	SUGGESTED HARNESS ROUTING	COMPATIBLE HARNESSES	COMPATIBLE AUDIO DEVICES
ULTIMATE HARNESS	▶ 2881617	<ul style="list-style-type: none"> Use to power audio devices (one in front, two in rear) Use to power overhead LED light bars (two in front, one in rear) Provides connection point for subwoofer Provides three rocker switches to control lights Provides circuit protection 	<p>ROUTING ROPS</p> <ul style="list-style-type: none"> Bullet connectors route through hole at top of passenger side A-pillar, down the ROPS, and come out through the coupler welded to the tube. Bullets should then route through slot in lower right front fender One audio and two light connectors hang out of hole at top of passenger side A-pillar Remaining two audio connectors and one light connector route along ROPS to rear (B-pillar) <p>ROUTING DASH</p> <ul style="list-style-type: none"> Connect to Ultimate ROPS at lower right front fender under hood Push relay/fuse holders into firewall at ACC positions 2 and 3 Connect ring terminals to terminal block (Orange = ACC, Brown = GND, Red = BATT) Route switch connectors through grommet provided in firewall and insert connectors into upper panel 	MTX® Adapter 4-Seat Ext	<ul style="list-style-type: none"> Extreme Audio Pods Soundbar MTX® Front Pod (w/ MTX® adapter) MTX® Rear Pod (w/ MTX® adapter) None
DELUXE HARNESS	▶ 2879865	<ul style="list-style-type: none"> Includes two rocker switches, radio harness and connection for two LED light bars Ideal harness for multiple LED light bars and audio system 	<p>ROUTING ROPS</p> <ul style="list-style-type: none"> Route subwoofer connector through hole at top of driver side A-pillar, down the ROPS, and come out through the coupler welded to the tube. Connector should then route through slot in lower left front fender to subwoofer. Connect to subwoofer. Connector at other end should hang out of hole at top of driver side A-pillar <p>ROUTING DASH</p> <ul style="list-style-type: none"> Connect to MTX® front or MTX® rear at top of driver side A-pillar Connect to Y-harness using audio signal connector Leave extra 8-pin connector at top of driver side A-pillar (used only if connecting an MTX® front pod to an MTX® rear pod) Route 4-pin connector across front crossbar from driver side A-pillar to passenger side A-pillar. Plug into empty power connector at passenger side A-pillar if possible. Otherwise, connect 4-pin connector to 4-seat extension harness at top of passenger side A-pillar, route 4-seat extension harness along ROPS to passenger B-pillar and plug into empty power connector. 	MTX® Adapter 4-Seat Ext	<ul style="list-style-type: none"> Extreme Audio Pods Soundbar MTX® Front Pod (w/ MTX® adapter) MTX® Rear Pod (w/ MTX® adapter) None
SUBWOOFER	▶ 2881647	<ul style="list-style-type: none"> Used to get audio signal from source unit to subwoofer 	<ul style="list-style-type: none"> Route subwoofer connector through hole at top of driver side A-pillar, down the ROPS, and come out through the coupler welded to the tube. Connector should then route through slot in lower left front fender to subwoofer. Connect to subwoofer. Connector at other end should hang out of hole at top of driver side A-pillar 	Y-Harness	<ul style="list-style-type: none"> Subwoofer Soundbar MTX® Front Pod
MTX® ADAPTER	▶ 2881648	<ul style="list-style-type: none"> Used as an adapter to allow MTX® audio equipment to connect to newer audio devices 	<ul style="list-style-type: none"> Connect to MTX® front or MTX® rear at top of driver side A-pillar Connect to Y-harness using audio signal connector Leave extra 8-pin connector at top of driver side A-pillar (used only if connecting an MTX® front pod to an MTX® rear pod) Route 4-pin connector across front crossbar from driver side A-pillar to passenger side A-pillar. Plug into empty power connector at passenger side A-pillar if possible. Otherwise, connect 4-pin connector to 4-seat extension harness at top of passenger side A-pillar, route 4-seat extension harness along ROPS to passenger B-pillar and plug into empty power connector. 	Y-Harness 4-Seat Ext	<ul style="list-style-type: none"> MTX® Front Pod MTX® Rear Pod
POLARIS INTERACTIVE DIGITAL DISPLAY ACCESSORY	▶ 2881649	<ul style="list-style-type: none"> Provides connectors for front camera, rear camera, one audio device, and USB 	<ul style="list-style-type: none"> Plug 24-pin connector into backside of Keystone Route ring terminals through grommet provided in firewall and attach to terminal block (Red = BATT, Black = GND) 	Line Out Harness Rear Audio Harness	<ul style="list-style-type: none"> Polaris Interactive Digital Display
4-SEAT EXT	▶ 2881650	<ul style="list-style-type: none"> Extends power connector to reach rear of 4-seat RZR® vehicles 	<ul style="list-style-type: none"> Connect one end of harness to the audio power connector at passenger side B-pillar Route other end along ROPS to rear (C-pillar) 	Rear Audio Harness Ultimate Harness	<ul style="list-style-type: none"> Extreme Audio Pods Soundbar MTX® Front Pod (w/ MTX® adapter) MTX® Rear Pod (w/ MTX® adapter)
AUDIO Y-HARNESS	▶ 2881651	<ul style="list-style-type: none"> Splits audio signal to provide additional audio connection points 	<ul style="list-style-type: none"> All three connectors should be located at top of driver side A-pillar. Any other required harnesses will connect to the Y-harness at top of driver side A-pillar 	Line Out Harness Subwoofer Harness MTX® Adapter	<ul style="list-style-type: none"> Extreme Audio Pods Soundbar MTX® Front Pod (w/ MTX® adapter) MTX® Rear Pod (w/ MTX® adapter)
LINE OUT	▶ 2881652	<ul style="list-style-type: none"> Used to send and receive audio signals from source unit 	<ul style="list-style-type: none"> One end of the harness should be left at the top of driver side A-pillar. Other end of harness should be routed along ROPS to driver side B-pillar, then across the rear crossbar to the passenger side B-pillar. If this harness is used with Keystone: <ul style="list-style-type: none"> Leave one end at top of driver side A-pillar. Route other end through the hole at the top of driver side A-pillar, down the ROPS, and come out through the coupler welded to the tube. Connector should then route through slot in lower left front fender and connect to Keystone Accessory Harness. 	Polaris Interactive Digital Display Adapter Y-Harness	<ul style="list-style-type: none"> Polaris Interactive Digital Display (with Adapter) Bluetooth® Controller Extreme Audio Pods

LIGHTING HARNESSES

HARNESS	PART NO.	FEATURES	FITMENT
BUSBAR HARNESS	▶ 2879862	<ul style="list-style-type: none"> The busbar harness is required for the installation of larger LED light bars (2879858, 2890527, 2879499, 2879502) This wire harness kit allows for additional power draw from the busbar 	RZR® XP 1000 MY 14-15, RZR® 900 MY 15, RZR® S 900 MY 15, RZR® 900 XC MY 15
	▶ 2881551		RZR® XP 1000 MY 16, RZR® 900 MY 16, RZR® S 900 MY 16, RZR® 900 XC MY 16, RZR® S 1000 MY 16, RZR® XP TURBO MY 16
	▶ 2881646		RZR® XP 4 1000 MY 16, RZR® 4 900 MY 16
	▶ 2880055		2880055 RZR® XP 4 1000 MY 14-15, RZR® 4 900 MY 15
LED HARNESS	▶ 2879859	<ul style="list-style-type: none"> This wire harness is designed to seamlessly route through the RZR XP® 1000 cab frame so no loose wires are exposed Includes rocker switch and connection for one LED light bar 	RZR® XP 1000 MY 14-16, RZR® 900 MY 15-16, RZR® S 900 MY 15-16, RZR® 900 XC MY 15-16, RZR® S 1000 MY 16, RZR® XP TURBO MY 16, RZR® XP 4 1000 MY 15-16, RZR® 4 900 MY 15-16
DUAL LED HARNESS	▶ 2879860	<ul style="list-style-type: none"> This harness needs to be used in addition to LED Harness (2879559) or Deluxe LED Harness 2879865 This harness allows for two LED light bars to be controlled by one switch 	RZR® XP 1000 MY 14-16, RZR® 900 MY 15-16, RZR® S 900 MY 15-16, RZR® 900 XC MY 15-16, RZR® S 1000 MY 16, RZR® XP TURBO MY 16, RZR® XP 4 1000 MY 15-16, RZR® 4 900 MY 15-16
DUAL LIGHT HARNESS	▶ 2878770	<ul style="list-style-type: none"> Connections for 2 LED Lights, auxiliary switch 	RZR® 570 MY 12-16, RZR® 800 MY 08-14, RZR® 4 MY 10-14, RZR® 900 MY 11-16, RZR® 900 4 MY 12-14
RZR® UNIVERSAL LED HARNESS	▶ 2879863	<ul style="list-style-type: none"> This harness is required for installation of LED Headlight Kits (sold separately) on your Polaris® RZR® Includes rocker switch and connection for one LED light bar 	RZR® 570 MY 12-16, RZR® 800 MY 08-14, RZR® 4 MY 10-14, RZR® 900 MY 11-16, RZR® 900 4 MY 12-14

TECHNOLOGY



POLARIS® INTERACTIVE DIGITAL DISPLAY 2.0

NEW FEATURES

- Control of Bluetooth® audio media streaming with track and artist display
- Backup camera display requires Reverse Camera (2881653)
- Forward camera display (if enabled and supported by hardware, will be added to the main screens when cycling using the far left button)
- Exporting capabilities for created tracks and waypoints from the display to USB drive
- Course up arrow option with rotating background map now available
- Distance to a selected Waypoint shown on the Map screen
- Automatic Day/Night Brightness change based on time of day and day of year
- New riding screen with increased visibility to important diagnostics, gear indicator enlarges on gear change

STANDARD FEATURES

- High resolution, 4.3" full color LCD display
- Bluetooth® connectivity allows you to pair your smart phone and check missed calls, text message, battery life and signal strength
- Diagnostics screen displays vehicle fault codes (NEW: Voltage and engine temp faults will pop up and turn red at critical levels)
- GPS Connectivity offers exact location information including elevation, latitude/longitude and compass bearings

▶ 2881554

RZR XP® 1000 MY 14-16, RZR XP® 4 1000 MY 14-16, RZR XP® TURBO MY 16, RZR® 1000 S MY 16, RZR® 4 900 MY 15-16, RZR® 900 MY 14-16, RZR® 900 S MY 15-16, RZR® 900 XC EDITION MY 15-16 Requires Polaris® Interactive Digital Display Install Kit (2880497)

REVERSE CAMERA ACCESSORY

▶ 2881653

POLARIS® INTERACTIVE DIGITAL DISPLAY INSTALL KIT

- Install Kit accompanies the most advanced instrumentation and ride-monitoring technology available in your RZR®. This kit includes everything required to install the (Polaris® Interactive Digital Display) (sold separately) replaces the stock instrument gauge in your choice of locations in the RZR®.
- Includes all new instrument panel, necessary mounting hardware, wiring harness, etc. to install the Polaris® Interactive Digital Display.

▶ 2880497

RZR® XP 1000 MY 14-16, RZR® XP 4 1000 MY 14-16, RZR® 900 MY 15-16, RZR® S 900 MY 15-16, RZR® XC 900 MY 15-16, RZR® 4 900 MY 15-16, RZR® 4 900 MY 15-16, RZR® S 1000 MY 16, RZR® XP TURBO MY 16

This is required for installing the Polaris Interactive Digital Display (2881554)



Connect your device and play your favorite songs



Check missed calls and text messages without pulling out your phone

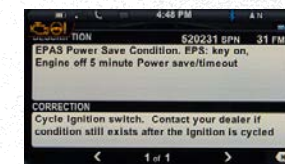

Diagnostics screen displays fault codes and suggested actions to take

TOP 4 GREAT NORTH AMERICAN TRAIL ALTERNATIVES



Dune riders who love Glamis, CA need to try Oregon Dunes National Recreation Area.



Trail riders might know about Brimstone, TN, but have you heard about Taylor Park, CO?



Desert riders flock to Moab, UT. The Hualapai ATV Trails in Mesa, AZ are an awesome alternative.



Paiute Trails, UT is popular. But the Hatfield-McCoy Trails of southern WV are a great ride, too.

TIRES & WHEELS



PRO ARMOR

For over a decade, Pro Armor® has been recognized as an industry leader in premium off-road accessories. Polaris® has partnered with Pro Armor® to produce a line of tires specially made for Polaris® vehicles. All featured tires are designed for a seamless fit and finish.

FULL TREAD. FULL STYLE.

No component is as important as a quality set of tires and wheels. Our completely new selection of off-road specialist Pro Armor® tires and rugged, stylish wheels deliver the performance and durability you demand wherever you're riding.

BUILD YOUR SET BY SELECTING THE BEST TIRE AND WHEELS FOR WHERE YOU RIDE.

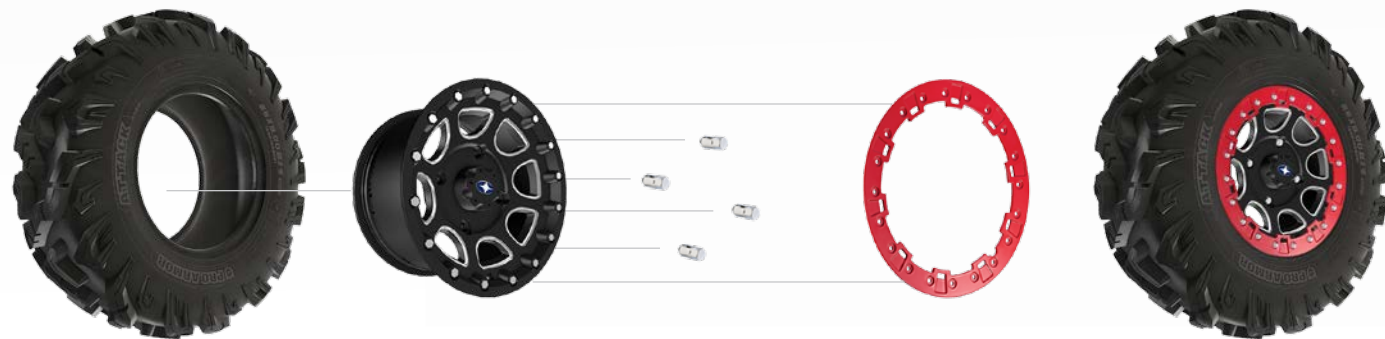

STEP 1

SELECT YOUR TIRES

Choose the tread that best suits your particular riding conditions.

STEP 2

SELECT YOUR WHEELS

Add some style to your ride with a set of tough, attention-stealing wheels.

STEP 3

SELECT YOUR LUG NUTS

Lug nuts not included with wheels or tires.

STEP 4

SELECT YOUR RINGS

Protect your bead lock rings while adding some flair to your wheels.

STEP 5

FINALIZE YOUR SET

Using your tire and wheel selection, select your set and order by visiting your local dealer or learn more by going to Polaris.com.

STEP 1 SELECT YOUR TIRES



• Tread patterns optimized for extreme traction
• Side walls tested for supreme durability
• Ideal for both hard pack and loose trail



• Industry leading anti-puncture side walls
• Aggressive long lasting tread



• Provides traction and durability
• Built to perform in sand, jagged rocks or any other extreme terrain



• Extra deep treads
• Full wall side bite



• Provides traction and durability
• Built to perform in sand, jagged rocks or any other extreme terrain



• Handles extreme cold
• Holds shape and provide traction



• Flexible "grippy" tread
• Aggressive side bite



PRO ARMOR® ATTACK TIRE

- Unique full-face tread design provides all season traction in any terrain
- Harder durometer lugs promotes extended wear tire life
- Durable 8-ply sidewall resists punctures and leaks
- Also available as a complete wheel and tire combination package

» FRONT | 5415613 | 26" x 9" x 14"
» REAR | 5415614 | 26" x 11" x 14"

ALL RANGER®, RZR®, SPORTSMAN® AND ACE® MODELS



PRO ARMOR® HAMMER TIRE

- Block pattern tread design delivers ideal varied trail and desert traction
- High durometer lug pattern withstands heat, abuse and promotes long tire life
- Large 30-inch design for high-performance applications
- Durable 8-ply sidewall resists punctures and leaks
- Also available as a complete wheel and tire combination package

» FRONT | 5415615 | 30" x 9.5" x 15"
» REAR | 5415615 | 30" x 9.5" x 15"
RZR® XP 1000 MODELS, RZR® XP TURBO



PRO ARMOR® CRAWLER XG TIRE

- Combination square block profile and soft durometer tread design
- Ideal for rock crawling and general trail and desert conditions
- Large 30-inch design for high-performance applications
- Durable 8-ply sidewall resists punctures and leaks
- Also available as a complete wheel and tire combination package

» FRONT | 5415616 | 30" x 10" x 14"
» REAR | 5415616 | 30" x 10" x 14"
RZR® XP 1000 MODELS, RZR® XP TURBO



PRO ARMOR® CRAWLER XR TIRE

- Combination square block profile and soft durometer tread design
- Ideal for rock crawling and general trail and desert conditions
- Compact 28-inch design fits many of today's stock vehicle applications
- Durable 8-ply sidewall resists punctures and leaks
- Also available as a complete wheel and tire combination package

» FRONT | 5415536 | 28" x 10" x 14"
» REAR | 5415536 | 28" x 10" x 14"
ALL RZR® MODELS



PRO ARMOR® DAGGER TIRE

- Multi-performance tire for both mud and loose trail conditions.
- Deep, self-cleaning lug and wide tire design for exceptional mud pit performance
- Rounded profile and "fuller" lug pattern for comfortable on-trail attributes
- Durable 8-ply sidewall resists punctures and leaks
- Also available as a complete wheel and tire combination package

» FRONT | 5415617 | 27" x 9" x 14"
» REAR | 5415617 | 27" x 9" x 14"
ALL RANGER®, RZR®, SPORTSMAN® MODELS



PRO ARMOR® ANARCHY TIRE

- Ultra deep lugs provide maximum traction in the worst mud conditions
- Self-cleaning grooves help maintain maximum traction
- Deep sidewall tread delivers added bite in off-camber conditions
- Wide tire design prevents loss of traction in rutted terrain
- Durable 8-ply sidewall resists punctures and leaks

» FRONT | 5415535 | 29.5" x 9" x 14"
» REAR | 5415535 | 29.5" x 9" x 14"
RANGER XP® 900 HIGH LIFTER EDITION, SPORTSMAN® 850/XP 1000 HIGH LIFTER EDITION, RZR® XP 1000 MODELS AND RZR® XP TURBO



PRO ARMOR® SAND TIRE

- Precision engineered 14-paddle REAR tires offer the ultimate in sand acceleration
- Unique 3-tiered FRONT tire design delivers hard turning bite and straight-line tracking
- Lightweight with flexible sidewalls creates added flotation and stability
- Developed to handle extreme horsepower and high-performance riding
- Also available as a complete wheel and tire combination package

» FRONT | 5415251 | 30" x 11" x 14"
» REAR | 5415252 | 30" x 13" x 14"
RZR® XP 1000 MODELS AND RZR® XP TURBO
Available in September 2015



PRO ARMOR® DUNE TIRE

- Affordable sand specific tire ideal for first time dune riders or as a secondary set
- Three-tiered FRONT tire serves up predictable cornering in loose sand
- Lightweight 12-paddle REAR tires tout a flexible sidewall for flotation and acceleration
- Also available as a complete wheel and tire combination package

» FRONT | 5415533 | 28" x 9" x 14"
» REAR | 5415534 | 28" x 11" x 14"
ALL RZR® MODELS
Available in September 2015



PRO ARMOR® XD-K TIRE

- Triple belted, Kevlar sidewall ensures extreme puncture resistance
- Rugged 8-ply tire face construction
- Aggressive 1.25" lugs
- REAR tires load rated at 1330lbs; FRONT tires load rated at 1000lbs

» FRONT | 5415756 | 26" x 9" x 12"
» REAR | 5415757 | 26" x 11" x 12"
ALL RANGER®, RZR®, SPORTSMAN® AND ACE® MODELS



Polaris® stock 12" wheels



TERRAINARMOR® NON-PNEUMATIC TIRES

Never get a flat with revolutionary TerrainArmor™ tire technology, the industry's first Non-Pneumatic tire built to sustain damage without compromising functionality or mobility. This polymeric web design can withstand harsh terrain.

» 2880818 | 8" TerrainArmor™ Tire Kit | Includes 4 8" tires & 6 speed key kit
RANGER XP® 900 FULL-SIZE MY 13-16, CREW XP 900 MY 14-16, XP 570 MY 15-16, CREW 570 FULL-SIZE MY 15-16

Ball joint upgrade kit (PN 2880928) required for XP 900 MY13-14, CREW XP 900 MY13-14
*Warranty in accordance with Polaris' recommended usage, including designated payload capacities and limiting speed to 25 mph with speed key kit



1 Year Limited Warranty

TIRES & WHEELS CONTINUED

STEP 2 SELECT YOUR WHEELS



LYTE 14" WHEEL

- » FRONT | 14" x 8"
Accent | 1522548-266
Black | 1522548-458
- » REAR | 14" x 10"
Accent | 1522549-266
Black | 1522549-458

RZR® XP 1000

Only fits with Sand and Dune tires



HEXLR 15" WHEEL

- » FRONT/REAR | 15" x 7"
Titanium | 1522173-654
Black | 1522173-458

FITS RZR® XP 1000

Only fits with Hammer tire
Requires Billet Rings (See Step 4)



REBLR 14" WHEEL

- » FRONT | 14" x 7" | 1522238-458
- » REAR | 14" x 8" | 1522239-458

ALL RANGER®, RZR®, SPORTSMAN® AND ACE® MODELS

Requires Billet Rings (See Step 4)



THRASHER 14" WHEEL

- » FRONT | 14" x 6"
Luster | 1522241-410
Black | 1522241-458
- » REAR | 14" x 8"
Luster | 1522242-410
Black | 1522242-458

SPORTSMAN® 850 AND SPORTSMAN® XP 1000 MODELS



WYDE 15" WHEEL

- » FRONT/REAR | 15" x 7"
ACCENT | 1522550-266
- » FRONT/REAR | 15" x 7"
BLACK | 1522550-458

RZR® XP 1000 MODELS

*Only fits Hammer tire



SHACKLE 14" WHEEL

- » FRONT | 14" x 7"
ACCENT | 1522546-266
BLACK | 1522546-458
- » REAR | 14" x 8"
ACCENT | 1522547-266
BLACK | 1522547-458

ALL RANGER®, RZR®, SPORTSMAN® AND ACE® MODELS



BUCKLE 14" WHEEL

- » FRONT | 14" x 7"
ACCENT | 1522544-266
BLACK | 1522544-458
- » REAR | 14" x 8"
ACCENT | 1522545-266
BLACK | 1522545-458

ALL RANGER®, RZR®, SPORTSMAN® AND ACE® MODELS



SPLIT 14" WHEEL

- » FRONT | 14" x 6" | 1522542-458
- » REAR | 14" x 8" | 1522543-458

ALL RANGER®, RZR®, SPORTSMAN® AND ACE® MODELS



SIXR 14" WHEEL

- » FRONT 14" x 7"
LUSTER | 1521507-410
BLACK | 1521507-521
MACHINED | 1521507-266
- » REAR 14" x 8"
LUSTER | 1521508-410
BLACK | 1521508-521
MACHINED | 1521507-266

ALL RANGER®, RZR®, SPORTSMAN® AND ACE® MODELS



1522243

1521509



1522675-458

REPLACEMENT CENTER CAPS

- » 1522243-437 | LUSTER
- » 1522243-458 | FLAT BLACK
ONLY FITS THRASHER AND HEXLR

- » 1521509-410 | LUSTER
- » 1521509-521 | FLAT BLACK
FITS ALL WHEELS EXCEPT THRASHER,
HEXLR AND WYDE
Requires 14" Forge Billet Rings
1522244-133, 1522244-293 or
1522244-589

- » 1522675-458 | FLAT BLACK
ONLY FIT WYDE® WHEELS

STEP 3 SELECT YOUR LUG NUTS



12 MM LUG NUT KITS

- » 2877385 | SET OF 16 | WITH WRENCH
- » 2877384 | SET OF 4 | NO WRENCH
- » 2204966 | 12 mm LUG NUT WRENCH
SPORTSMAN® 1000, 850 AND ALL SCRAMBLER
MODELS

SAE® LUG NUTS FOR ALUMINUM WHEELS

- » 2876754 | SET OF 4
- » 2877409 | SET OF 16
SPORTSMAN® 570 AND EXT MODELS

STEP 4 SELECT YOUR RINGS



FORGE BILLET RINGS

• Add high-performance custom style along with reinforced tire mounting security with a set of these Machined Beadlock Rings.

- » VOODOO BLUE | 14" | 1522244-619
- » MACHINED | 14" | 1522244-266
- » WHITE | 14" | 1522244-133
- » INDY RED | 14" | 1522244-293
- » ORANGE CRUSH | 14" | 1522244-589
- » VOODOO BLUE | 15" | 1522240-619
- » MACHINED | 15" | 1522240-266
- » WHITE | 15" | 1522240-133
- » INDY RED | 15" | 1522240-293
- » ORANGE CRUSH | 15" | 1522240-589

14" OR 15" BEADLOCK WHEELS
Sold individually

STEP 5 FINALIZE YOUR SET (4 WHEELS PER SET)

TIRES

Using your tire and wheel selection, select your set and order by visiting your local Polaris® dealer or learn more at Polaris.com.

PRO ARMOR® ATTACK 14" FRONT: 5415613 REAR: 5415614	PRO ARMOR® HAMMER 15" FRONT: 5415615 REAR: 5415615	PRO ARMOR® CRAWLER XR 30" FRONT: 5415616 REAR: 5415616	PRO ARMOR® CRAWLER XG 28" FRONT: 5415636 REAR: 5415636	PRO ARMOR® DAGGER 14" FRONT: 5415617 REAR: 5415617	PRO ARMOR® ANARCHY 14" FRONT: 5415635 REAR: 5415635	PRO ARMOR® SAND 14" FRONT: 5415251 REAR: 5415252 Available September 2015	PRO ARMOR® DUNE 14" FRONT: 5415633 REAR: 5415634 Available September 2015

WHEELS

	BUCKLE 14" - ACCENT FRONT: 152244-266 REAR: 1522545-266	2881335	-	2881560	2881343	2881337	2881341	2881339	2881345
	BUCKLE 14" - BLACK FRONT: 1522544-458 REAR: 1522545-458	2881336	-	2881561	2881344	2881338	2881342	2881340	2881346
	SHACKLE 14" - ACCENT FRONT: 1522546-266 REAR: 1522547-266	2881347	-	2881558	2881355	2881349	2881353	2881351	2881357
	SHACKLE 14" - BLACK FRONT: 1522546-458 REAR: 1522547-458	2881348	-	2881559	2881356	2881350	2881354	2881352	2881358
	SIXR 14" - LUSTER FRONT: 1521507-410 REAR: 1521508-410	2881359	-	2881564	2881371	2881362	2881368	2881365	2881374
	SIXR 14" - BLACK FRONT: 1521507-521 REAR: 1521508-521	2881360	-	2881563	2881372	2881363	2881369	2881366	2881375
	SIXR 14" - MACHINED FRONT: 1521507-266 REAR: 1521508-266	2881361	-	2881562	2881373	2881364	2881370	2881367	2881376
	THRASHER 14" - LUSTER FRONT: 1522241-410 REAR: 1522242-410 Sportsman® XP 1000 only	2881377	-	-	-	2881379	2881445	-	-
	THRASHER 14" - FLAT BLACK FRONT: 1522241-458 REAR: 1522242-458 Sportsman® XP 1000 only	2881378	-	-	-	2881380	2881446	-	-
	REBLR 14" - FLAT BLACK FRONT: 1522238-458 REAR: 1522239-458 Requires Billet Rings (See Step 4)	2881381	-	2881382	2881386	2881383	2881385	2881384	2881387
	HEXLR 15" - BLACK FRONT: 1522173-458 REAR: 1522173-458 Requires Billet Rings (See Step 4)	-	2881388	-	-	-	-	-	-
	HEXLR 15" - TITANIUM FRONT: 1522173-654 REAR: 1522173-654 Requires Billet Rings (See Step 4)	-	2881389	-	-	-	-	-	-
	LYTE 14" - ACCENT FRONT: 1522548-266 REAR: 1522549-266	-	-	-	-	-	-	2881394	2881400
	LYTE 14" - BLACK FRONT: 1522548-458 REAR: 1522549-458	-	-	-	-	-	-	2881395	2881401
	WYDE 15" - ACCENT FRONT: 1522550-266 REAR: 1522550-266	-	2881402	-	-	-	-	-	-
	WYDE 15" - BLACK FRONT: 1522550-458 REAR: 1522550-458	-	2881403	-	-	-	-	-	-
	SPLIT 14" - BLACK FRONT: 1522542-458 REAR: 1522543-458	2881404	-	-	-	2881405	-	2881406	2881407

GLACIER® PRO PLOW SYSTEM

LOCK & RIDE



GLACIER® PRO PLOW

- Heavy-duty cast steel frame for maximum durability
- Lock & Ride® for easy blade installation and removal
- 66" W x 17" H heavy-duty blade
- Low-maintenance, self-contained electric over hydraulic cylinders
- Modular design lets you choose: hydraulic or winch lift
- Choice of blade angle control: hydraulic or manual angle
- Lift and angle adjustments can be made from the driver's seat
- Manual angle with shear pin design protects plow in high-impact contact
- Manual angle adjustment is easily accessible, prevents digging into snow to change angle
- Auto-retracting kickstand folds in as you drive away



STEP 1

SELECT A MOUNT

GLACIER® PRO PLOW MOUNT

- Heavy-duty steel frame with quick attach/detach plow mount linkage
- Adjustable plow breakaway tension springs
- Manual blade pivot adjustment to direct snow load
- Engineered to withstand season after season of big plowing jobs

» 2880262

RZR® 900 MY 15-16, RZR® S 900 MY 15-16, RZR® 900 XC MY 15-16, RZR® 4 900 MY 15-16, RZR® S 1000 MY 16

DOES YOUR VEHICLE HAVE TRACKS?

GLACIER® PRO PLOW EXTENSION

» 2880267

ALL GLACIER® PRO ATV PLOW MOUNTS Plow Extension for use when using the Prospector Pro® Track System

STEP 2

SELECT A FRAME

GLACIER® PRO PLOW FRAME

» 2880260

RZR® 900 MY 15-16, RZR® S 900 MY 15-16, RZR® 900 XC MY 15-16, RZR® 4 900 MY 15-16, RZR® S 1000 MY 16

STEP 3

SELECT A LIFT METHOD

CHOOSE A POLARIS® WINCH:

POLARIS® PRO HD 4500 LB. WINCH

POLARIS® HD 3500 LB. WINCH

WARN® PROVANTAGE 4500 LB. WINCH

WARN® PROVANTAGE 3500 LB. WINCH

See Pages 30 - 31 for product details

ADD AN ANGLE SYSTEM:

GLACIER® PRO HYDRAULIC ANGLE SYSTEM

- Hydraulic plow blade angle control attaches to Glacier® Pro Frame
- From the cab convenience with push button control
- Fast and precise control gets the job done faster

» 2880266

RZR® 900 MY 15-16, RZR® S 900 MY 15-16, RZR® 900 XC MY 15-16, RZR® 4 900 MY 15-16, RZR® S 1000 MY 16



STEP 4

SELECT A BLADE

GLACIER® PRO 66" POLY BLADE

- Wide 66-inch blade with forward angled snow holding corners
- Lightweight polyethylene blade with steel backbone construction
- Poly material stays flexible in all temperatures and will not rust
- Energy absorption design reduces stress on vehicle frame and suspension
- Includes replaceable metal wear bar

» 2880269

GLACIER® PRO 66" STEEL BLADE

- Solid-steel construction for durability and long-life performance
- Wide 66-inch blade for maximum snow moving capabilities
- Includes replaceable metal wear bar

» 2880268

GLACIER® II PLOW SYSTEM

LOCK & RIDE



GLACIER® II PLOW

- Lock & Ride® installation: Easy, installation/removal of plow blade
- Reinforced frame to withstand the greater demands of utility vehicle plowing
- Designed specifically for the RZR®; not a generic size like most aftermarket kits
- Choose from several available blades for the most efficient plowing

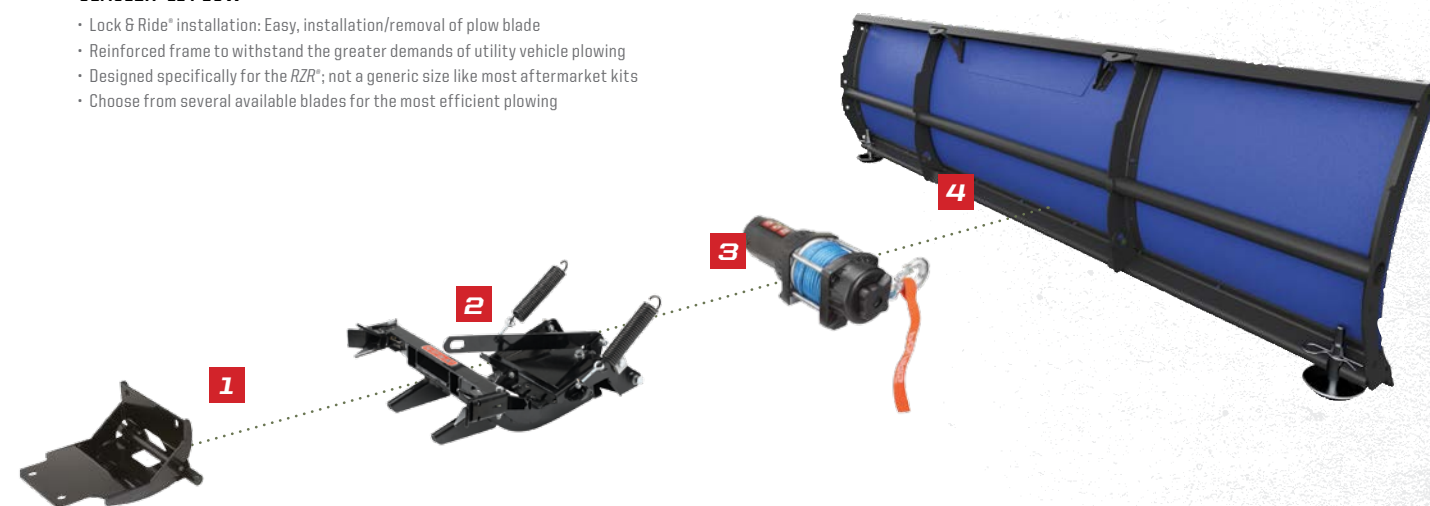

STEP 1

SELECT A MOUNT

GLACIER® II PLOW MOUNT

- Strong, durable, reliable steel Plow Mount attaches securely to vehicle frame and is ready to accept a plow blade whenever it's time to plow
- Mount bolts securely under vehicle & can be left in place permanently, including when not plowing

» 2878824

RZR® 570 MY 12-16, RZR® 800 MY 08-14, RZR® S MY 09-14

STEP 2

SELECT A FRAME

GLACIER® II PLOW FRAME

» 2878822

RZR® 570 MY 12-16, RZR® 800 MY 08-14, RZR® S MY 09-14

STEP 3

SELECT A LIFT METHOD

CHOOSE A POLARIS® A WINCH:

POLARIS® PRO HD 4500 LB. WINCH

POLARIS® HD 3500 LB. WINCH

WARN® PROVANTAGE 4500 LB. WINCH

WARN® PROVANTAGE 3500 LB. WINCH

See Pages 30 - 31 for product details

STEP 4

SELECT A BLADE

GLACIER® PRO 66" STEEL BLADE

» 2880268

66" SNO-GLIDE BLADE

» 2878686

60" RAZOR BLADE® TWO-WAY

» 2875370

60" SNOW BLADE

» 2876626

52" SNOW BLADE

» 2876627

PLOW ACCESSORIES

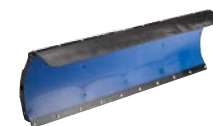

PLOW BLADE SNOW DEFLECTOR

- Helps confine snow, boosting plow capacity
 - Designed for easy on and off
- » 2879866 | 66"
» 2871808 | 60"



PLOW MARKER

- Helps driver monitor plow blade position
 - Sold in pairs
- » 2872726



REAR TIRE CHAINS

- Size C, for 25" (63.5 cm) or 26" (66 cm) tires
- » 2877952

OUTER WEAR BAR (NOT SHOWN)

- Strong, durable Wear Bar will hold up over long hours of plowing
- Designed to fit as a direct replacement for your Polaris® blade
- Easy to install using simple hand tools
- Sold as a set

» 2204625

SNO-GLIDE SKID SHOE (NOT SHOWN)

» 2873423

REAR STEEL SUPPORT (NOT SHOWN)

» 2204624

PROSPECTOR PRO[®] TRACK SYSTEM



- Polaris[®]-specific gearing provides 1:1 ratio to:
- Minimize track slip, providing better climbing ability and improved traction in deep snow
 - Improves top speed over prior models by approximately 5%
 - Reduce operating RPM for a quieter ride
 - Improve driveline durability, which allows vehicle to run at a lower RPM, decreasing engine wear

Flexible lug design for the highest level of deep snow performance by lifating up in deep snow as opposed to digging down

Polaris[®] Exclusive optimized hub geometry that minimizes feedback and eases steering effort

New front dual stabilizer for improved stability

Lightweight design with slight weight reduction over Camoplast kit provides for better flotation, eases steering effort and provides better vehicle control



1

SELECT A MOUNT

RZR[®] PROSPECTOR MOUNTS

- Dual bogie wheels manage weight properly & deliver a great ride & outstanding traction in snow
- Prospector Pro[®]-SR Tracks (sold separately) greatly enhance traction, flotation & mobility in snow

- » 2880648
RZR[®] 900 MY 15-16, RZR[®] 900, RZR[®] XC MY 15-16
- » 2880649
RZR[®] S 900 MY 15-16, RZR[®] S 1000 MY 16
- » 2879453
RZR[®] 800 MODELS MY 08-14
- » 2879749
RZR[®] S MODELS MY 09-14
- » 2879750
RZR[®] 570 MODELS MY 12-14 ONLY

GLACIER PRO PLOW EXTENSION (GLACIER PRO ONLY)

- Plow on a RZR[®] that is equipped with Prospector Pro[®] Track System
- Extends beyond front tracks to accommodate plow blade mounting
- Ensures full plow performance

- » 2880267
RZR[®] 900 MY15, RZR[®] S 900 MY15, RZR[®] 900 XC MY15-16

2

SELECT A KIT

TRACKS PROSPECTOR PRO[®]

- Lightweight track conversion for optimum snow performance and traction
- Optimized hub geometry minimizes feedback and eases steering effort
- Harder durometer rubber compound delivers 4-season durability
- Camoplast Flexedge[®] technology reduces steering effort for improved control
- Flexible lug design improves lift, flotation and agility in deep snow
- Polaris[®]-specific gearing for improved performance and minimum track slip
- Improved top speed (+5%) over older track conversion kits
- Lower operating RPM for quieter ride
- Improved driveline durability
- Requires RZR[®] Prospector Mounts for specific model application

- » 2880757
XP 900 MY13-14, CREW 900 MY14-16
NON EPS: 20 FRONT 18 REAR
500 lb. maximum cargo load with tracks installed

- » 2880758
XP 900 MY13-14, CREW 900 MY14-16
EPS: 18 FRONT 18 REAR
500 lb. maximum cargo load with tracks installed
For use on models that come with factory-installed eps
Works with glacier pro only

YOUTH/RZR[®] 170



RZR[®] 170 SKID PLATE

- 3-piece construction for full coverage
- Extends full length of undercarriage
- Tough, durable .20"-thick polyethylene

- » 2878343
RZR[®] 170 MY 09-16
- » 2880075
RZR[®] 170 MY 09-16



RZR[®] 170 HALF WINDSHIELD

- Provides protection from rain, debris, branches
- Installs easily and securely
- Retains open-air riding environment
- Adds sporty style

- » 2877684
RZR[®] 170 MY 09-16



RZR[®] 170 FRONT BRUSHGUARD

- Strong, tough and protective
- Protects front end of vehicle from impact
- Styling and finish complement vehicle's sporty look
- Easy bolt-on installation

- » 2877813
RZR[®] 170 MY 09-16



RZR[®] 170 SOFT TOP

- Adds sporty styling and offers protection
- Provides shade for riders
- Protects against rain and overhead branches, etc.
- Easy installation

- » 2877685
RZR[®] 170 MY 09-16

HELMETS



GREY FRACTAL



RED FRACTAL



ORANGE FRACTAL



BLUE FRACTAL



PODIUM 2



SLY



DOMINATE

FLY F2® HELMET

- Lightweight and impact resistant composite construction shell
- Aircraft grade woven carbon fiber and Kevlar® materials
- Dual density liner with two layers of energy absorbing material
- Removable washable liner and cheek pads feature plush sweat absorbing material
- Extensive through helmet cooling vents keep you comfortable in the heat
- Tri-flow goggle vents reduce fogging in cold or high humidity environments
- Custom molded trim and protective integrated nose guard.
- Snell® 2010 DOT and ECE approved
- Available in a wide range of colors and graphics
- Styled to match FLY® Off-Road Jersey and FLY® Off-Road Gloves

- » 2866203 | BLUE FRACTAL / NEW | XS-5XL
- » 2866201 | RED FRACTAL / NEW | XS-5XL
- » 2866202 | ORANGE FRACTAL / NEW | XS-5XL
- » 2866200 | GRAY FRACTAL / NEW | XS-5XL
- » 2866143 | PODIUM 2 | XS-5XL
- » 2865110 | SLY | XS-5XL
- » 2865112 | DOMINATE | XS-5XL

FLY F2® REPLACEMENT VISOR

- » 2866207 | REPLACEMENT VISOR- BLUE FRACTAL
- » 2866205 | REPLACEMENT VISOR- RED FRACTAL
- » 2866206 | REPLACEMENT VISOR- ORANGE FRACTAL
- » 2866204 | REPLACEMENT VISOR- GRAY FRACTAL

FLY F2® MOUTH PIECE

- » 2866211 | MOUTH PIECE- BLUE FRACTAL
- » 2866209 | MOUTH PIECE- RED FRACTAL
- » 2866210 | MOUTH PIECE- ORANGE FRACTAL
- » 2866208 | MOUTH PIECE- GRAY FRACTAL

FLY® REPLACEMENT PARTS

- » VISOR SCREW KIT | 2863162
- » COLD WEATHER PLUG KIT (XS/S) | 286316401
- » COLD WEATHER PLUG KIT (M/L) | 286316403
- » COLD WEATHER PLUG KIT (XL/2XL) | 286316409
- » BREATH DEFLECTOR | 2863165
- » CHEEK PAD-20MM | 2863195
- » CHEEK PAD-25MM (2XL) | 2863196
- » CHEEK PAD-30MM (L) | 2863197
- » CHEEK PAD-35MM (S, M, L) | 2863198
- » CHEEK PAD-40MM (XS) | 2863199

NEW IMPROVED FIT!
BETTER COMFORT. BETTER RIDE.
SEE IT IN ACTION AT POLARIS.COM/SHOP



BLUE GLOSS



Removable Breath Deflector



RED GLOSS



ORANGE GLOSS



BLACK GLOSS

DEMON HELMET

- Lightweight, protective composite fiberglass shell
- Dual density, removable EPS liner for impact absorption that is moisture-wicking QwickDry® and washable
- Aerodynamic, multi-channel flow-through ventilation system
- Snell® M2010 and DOT approved

- » 2866126 | RED GLOSS | XS-3XL
- » 2866127 | BLUE GLOSS | XS-3XL
- » 2866128 | ORANGE GLOSS | XS-3XL
- » 2866129 | BLACK GLOSS | XS-3XL

DEMON REPLACEMENT VISOR

- » RED GLOSS | 2866149
- » BLACK GLOSS | 2866150
- » ORANGE GLOSS | 2866151
- » BLUE GLOSS | 2866152

DEMON REPLACEMENT PARTS

- » BREATH DEFLECTOR | 2861233
- » VISOR SCREW KIT | 2869484
- » BREATH DEFLECTOR 2.0 | 2866153
- » CHIN CURTAIN 2.0 | 2866155



RED GLOSS



BLUE GLOSS



BLACK/LIME PUNCH



BLACK/GREY MATTE



BLACK MATTE

TENACITY HELMET

- Lightweight Polycarbonate shell
- Removable, washable liner
- Mouth air intake vent, eyebrow vents and six rear vents
- 3XL size is DOT approved only

- » 2866132 | RED GLOSS | XS-3XL
- » 2866133 | BLUE GLOSS | XS-3XL
- » 2866134 | BLACK/LIME PUNCH | XS-3XL
- » 2866135 | BLACK/GREY MATTE | XS-3XL
- » 2866136 | BLACK | XS-3XL

TENACITY REPLACEMENT VISOR

- » RED GLOSS | 2866144
- » BLUE GLOSS | 2866145
- » BLACK/LIME PUNCH GLOSS | 2866146
- » BLACK/GRAY MATTE | 2866147
- » BLACK MATTE | 2860204

TENACITY REPLACEMENT PARTS

- » VISOR SCREW KIT | 2862120
- » BREATH DEFLECTOR | 2861233

HELMET SAFETY



A proper fit should be a little tight at first. It will loosen up a bit as the helmet is broken in.

There are three helmet safety ratings you'll commonly see:

- DOT (US Department of Transportation)
- ECE (UN Economic Commission for Europe)
- Snell (a non-profit organization dedicated to helmet safety)

Never buy or sell used helmets. The pads have formed to a specific head shape, and will not work properly on a different head.

Helmets are designed to endure a single moderate impact. If involved in any significant crash, replace your helmet.

GOGGLES

509[®] FOR POLARIS[®]

509[®] DIRT PRO GOGGLES / NEW

- Oversized frame for wide field of vision
- Precision fit lenses with optimal clarity
- Durable anti-scratch and anti-fog lens coating
- Available replacement lenses including chrome, polarized and clear
- Hinged strap ensures a more positive fit on face
- Triple layer foam for added comfort and moisture wicking
- 13-port in-goggle venting promotes fresh ventilation
- Integrated and removable vented nose guard for added protection
- Sturdy three-post tear-off compatible (Requires Tear Off Pack 2863433)
- Perfect addition to FLY F2[®] Helmet and FLY[®] Off-Road Jersey

- » 2866212 | BLACK STANDARD (CLEAR LENS) | OSFM
- » 2866213 | ORANGE FRACTAL (CHROME LENS) | OSFM
- » 2866214 | BLUE FRACTAL (CHROME LENS) | OSFM
- » 2866215 | RED TECH (FIRE LENS) | OSFM
- » 2866216 | LIME TECH (CHROME LENS) | OSFM
- » 2866217 | RED FRACTAL (CHROME LENS) | OSFM

509[®] DIRT PRO REPLACEMENT LENSES (NOT SHOWN)

- » 2863430 | CHROME | OSFM
- » 2863431 | CLEAR | OSFM
- » 2863432 | BROWN POLARIZED | OSFM
- » 2863433 | TEAR-OFFS | 6 PER PACK | OSFM



RED TECH



ORANGE FRACTAL



BLUE FRACTAL



RED FRACTAL



BLACK STANDARD



LIME TECH



POLARIS[®] TRAIL GOGGLES

- » 2863434 | Black | OSFM

POLARIS[®] TRAIL GOGGLES REPLACEMENT LENS (NOT SHOWN)

- » 2863482 | Clear | OSFM

GLOVES



ORANGE FRACTAL

BLUE FRACTAL

RED FRACTAL

GRAY FRACTAL

FLY[®] OFF-ROAD GLOVES / NEW

- Outstanding protection, grip and comfort
- Lycra[®] back panels stretch for a perfect fit
- Soft-Flex TPR and embossed neoprene flex-knuckle system deliver protection
- Adjustable wrist closures for an assured fit
- Silicone finger grippers for wet driving conditions
- Reinforced thumb for long life durability
- Padded palm for added comfort and warmth
- Available in several colors to match your vehicle and gear
- Ideally suited for FLY[®] Off-Road Jersey and FLY F2[®] helmet

- » 2866218 | GRAY FRACTAL | S-3X
- » 2866219 | RED FRACTAL | S-3X
- » 2866220 | ORANGE FRACTAL | S-3X
- » 2866221 | BLUE FRACTAL | S-3X

JERSEYS



GRAY

PINK

ORANGE

RED

FLY[®] OFF-ROAD JERSEY / NEW

- Lightweight 100% polyester material in integrated mesh ventilation
- Vibrant sublimated graphics for high visibility and style
- Low profile, multi-directional Lycra[®] stretch collar for comfort
- Non-restrictive shorty cuffs and elastic sleeves for wide range of motion
- Extended tail keeps jersey tucked into pants
- Tagless design for irritation free comfort
- Available in five colors: gray, red, pink, orange and blue
- Matching FLY F2[®] helmet and FLY[®] Off-Road glove available

- » 2866222 | GRAY | S-3X
- » 2866223 | RED | S-3X
- » 2866224 | PINK | S-3X
- » 2866225 | ORANGE | S-3X

PROTECTION

TEKVEST



TEKVEST® FREESTYLE

- SHELL: Strong, protective UHMW panels cover shoulders; front and rear mesh panels promote cooling airflow
- FIT: Adjustable strap system for perfect fit
- SAFETY: Optional quick-attach shoulder pads available for upper arm coverage
- ADDITIONAL FEATURES: Large arm openings for unrestricted movement; can be used for snowmobiling and off-roading

» 2862189 | S-3X



TEKVEST® SUPER SPORT

- SHELL: Strong, protective UHMW panels cover shoulders
- FIT: Adjustable belt across lower back ensures proper fit
- SAFETY: Optional quick-attach shoulder pads available for upper arm coverage
- ADDITIONAL FEATURES: Zip-off fleece collar diffuses rising body heat to reduce fogging; large arm openings for unrestricted movement; drop-tail design for extended coverage; 2-stage pockets; can be used for snowmobiling and off-roading

» 2862190 | S-3X



YOUTH TEKVEST® (70-100 LB)

- SHELL: Strong, protective UHMW panels cover shoulders
- FIT: Adjustable side straps and arm straps
- SAFETY: Shoulder pads are included for upper arm protection

» 2862191 | Black



TEKVEST® SHOULDER PADS

- Quick-attach shoulder pads allow for upper arm coverage

» 2862192 | S-3X

YOUTH



INTRODUCING KIDS TO RIDING

- » Before anything else, make sure they have a youth helmet that fits properly.
- » Don't start your kids on a machine that's too powerful. Have 6-8 year olds begin with a 50cc ATV and a RZR® 170 for those 10-12.
- » Invest in quality bumpers & brushguards. Little accidents are going to happen.
- » Understanding terrain is essential. Teach them how to read and react to changing conditions.
- » Keep it fun. After all, that's what off-road riding is all about.



YOUTH FLY® OFF-ROAD JERSEY / NEW

All the same great features of our full-size jersey in a youth size. Enjoy the comfort fit, high-flow ventilation, wide range of movement and convenient features in your choice of red or pink color schemes. Why should adults have all the style?

- » 2866227 | Red Fractal | S-3X
- » 2866228 | Pink Fractal | S-3X



YOUTH MX HELMET

- » 2860174 | Black | S-M-L
- » 2862171 | Red | S-M-L
- » 2862172 | Blue | S-M-L



YOUTH RZ MASK

» 2863191 | Black | OSFM

YOUTH RZ MASK REPLACEMENT FILTERS (NOT SHOWN)

» 2863192 | OSFM | 3 per pack

POLARIS® YOUTH GOGGLES

» 2863435 | Black | OSFM



YOUTH AERO GLOVES

» 2862187 | Black | S-M-L

BEANIES & CAPS



YOUTH REVERSIBLE PRINTED BEANIE

- 100% Acrylic
- Soft screen print

- » 2866190 | Gray Cracked | OSFM
- » 2866191 | Pink Geo | OSFM



SIGNATURE BEANIE

- 100% Acrylic with 3M® Thinsulate®
- » 2865141 | Black/Charcoal | OSFM
- » 2865142 | Black/Red | OSFM



MEN'S ENDURED TRUCKER CAP

- White and black worn trucker style hat with red and grey contrasts and stitching
- Embroidered RZR® logo on front and back
- Snapback closure

» 2865156 | OSFM



WOMEN'S CADET CAP

- Grey cap with feminine shape and small front bill
- Embroidered RZR® logo on front
- D-ring black closure

» 2865163 | OSFM



MEN'S XP CAP

- White and black curved bill cap with red contrasts
- Flex-fit
- Embroidered RZR® logo on front and back

» 2865154 | S/M
» 2865155 | L/XL



MEN'S DUNES CAP

- Black flat bill cap
- Flex-fit
- Embroidered RZR® logo on front left and center back

» 2865157 | S/M
» 2865158 | L/XL

LAYERING



MEN'S U.P. BASE LAYER

- 93% polyester and 7% spandex jersey knit
- Reflective logos
- Lightest weight layering piece in the line-up

» Top | 2864030 | S-3X
» Bottom | 2864031 | S-3X



MEN'S KLONDIKE BASE LAYER

- 93% polyester, 7% spandex jersey knit
- Reflective logos
- Warmest layering piece in the line-up
- Soft-brushed liner for added warmth

» TOP | 2866006 | S-3X
» BOTTOM | 2866007 | S-3X



WOMEN'S KLONDIKE BASE LAYER

- 92% polyester, 8% spandex
- Soft-brushed liner for added warmth

» Top | 2866025 | S-3X
» Bottom | 2866026 | S-3X



ANNAPURNA MID LAYER

- 100% Polyester Polar Fleece, anti-static/anti-pill
- Zippered hand warmer pockets
- Contrast zipper, trim and cuffs
- Polaris® logo on left chest; ellipse on back of shoulders

» 2864020 | Black | S-5XL
» 2864019 | Navy | S-5XL



OPS TECH LONG SLEEVE

- Effective mid-layer in layering system
- AP-360® wicking and antimicrobial
- Excellent moisture wicking performance
- Far-infrared (heat enhancing), anti-static, anti-pill

» 2864096 | S-5XL

MEN'S APPAREL



TORQUE FULL ZIP HOODIE / NEW

- 100% cotton hoodie with contrasting red body and black sleeves
 - Vertical screened black and white RZR® logo on front
- » 2866070 | S-3X



PS-4 EXTREME PIT SHIRT / NEW

- 100% cotton woven black shirt
 - Polaris® branded metal button front
 - Vertical screen-printed red and gray RZR® logo and stripe
- » 2866071 | S-5X



DRIFT FULL ZIP HOODIE / NEW

- 100% cotton hoodie with bonded fleece knit
 - Gray overlaid with tonal "cracked" screen print
 - Small gray/white/red Polaris RZR® logo embroidered on back shoulder
- » 2866069 | S-3X



TERRACROSS HOODIE

- 80% Cotton, 20% Polyester
 - 280 GSM Poly knitted with softener
 - Embroidered RZR® logo and pouch pocket on front
- » 2865152 | S-3X



CRACKED HOODIE

- 100% cotton
 - Heat transfer technology
 - Fleece liner
- » 2866011 | S-3X



COLOR BLOCKED HOODIE

- 100% cotton
 - Fleece liner
 - Embroidered Polaris® logo
- » 2866010 | S-3X



TECH POLO

- 100% polyester mesh
 - Wicking treatment technology
 - Embroidered logo
- » 2866009 | S-5X



PS-4 PIT SHIRT

- 100% Cotton
 - Woven fabric
 - Embroidered logo
- » 2866042 | S-3XL

RJ ANDERSON APPAREL

JOIN THE RJ37 TEAM AND SHOW YOUR SUPPORT FOR ONE OF OFF-ROAD RACING'S BIGGEST STARS, RJ ANDERSON.



RJ37 CAP

- Black flat bill cap with red contrast stripe
 - Flex-fit
 - Embroidered RJ37 logo on top of bill
 - Embroidered RZR® logo on front left and center back
- » 2865166 | S/M
» 2865167 | L/XL



RJ37 TEE

- Red Tee with screen print on chest and trunk
 - 80% cotton, 20% polyester
 - 270 GSM
- » 2865164 | S-5X



RJ37 RACE HOODIE

- Black drawstring hoodie with red and gray contrasts
 - Embroidered RJ37 logo on front
 - Screen printed RZR® logos on sleeve and hood
 - Ribbed elastic wrists and bottom band
 - Two front hand pockets and front full zip
 - 80% cotton, 20% polyester 270 GSM
- » 2865165 | S-3X



BOOST FULL ZIP JACKET / NEW

- 92% polyester and 8% spandex blend with nylon facing
 - Grey with blue embroidered RZR® logo, zippers and stitching
 - Breathable, moisture wicking material keeps you comfortable
- » 2866067 | S-3X



LIFT QUARTER ZIP / NEW

- Blend of 92% polyester and 8% spandex
 - Screen-printed blue and white RZR® logo on right chest
 - Contrasting blue and black left sleeve
- » 2866068 | S-3X



LONG SLEEVE TECH QUARTER ZIP

- 92% polyester, 8% spandex
 - Heat Transfer technology
- » 2866008 | S-3X



RZR® CAD SHORT SLEEVE TEE / NEW

- 100% ringspun cotton shirt
 - Gray RZR® image in three views (side, front and overhead) on front
 - Gray vertical screened Polaris RZR® logo on back
- » 2866064 | S-3X



GARAGE SHORT SLEEVE TEE / NEW

- 100% ringspun gray cotton shirt
 - Soft hand-screened strip and contrasting black, red and white RZR® logo
- » 2866065 | S-3X



CLASSIC SHORT SLEEVE TEE / NEW

- 100% ringspun cotton shirt with contrast stitched seams
 - Halftone gradient Polaris RZR® logo screen print across chest
- » 2866066 | S-5X



RZR® SIGNATURE TEE

- Soft RZR® screen print on front
 - 100% cotton 160 GSM
- » 2865150 | Gray | S-3X



COME RIDE AT CAMP RZR®

Twice a year, RZR® owners from all over North America gather for Camp RZR®, a weekend of excitement, adrenaline and fun. From RZR® races to family events to gear giveaways, it's the most fun you can have on four-wheels. Visit camprzr.com for upcoming dates and locations.

WOMEN'S APPAREL



WOMEN'S DUNE 3/4 SLEEVE TEE / NEW

- 100% cotton
- RZR® screen-printed logo

» 2866074 | XS-3X



WOMEN'S CLASSIC TEE / NEW

- 100% cotton slub tee features subtle texturing for added comfort and style
- Embroidered RZR logo on left chest
- Water-based Polaris RZR® screen print

» 2866072 | XS-5X



WOMEN'S TRAIL TEE

- Black drawstring hoodie with feminine red and grey angled body contours
- Embroidered RZR logo on left chest
- Contrast zipper on left chest
- Ribbed elastic wrists and bottom band
- Two front hand pockets and front full zip
- 100% cotton, french terry
- 270 GSM

» 2865159 | S-2X



WOMEN'S TORQ TANK

- Thick strap solid black tank top
- Screen print vertical red RZR® logo up the side
- 100% Cotton
- 160 GSM

» 2865160 | Black | S-2X
» 2865161 | White | S-2X



WOMEN'S GARAGE TANK / NEW

- 100% cotton rib knit gray tank
- Water-based Polaris RZR® screen print

» 2866073 | XS-3X



WOMEN'S FLEECE VEST

- 100% polyester
- Micro fleece

» 2866029 | S-3X



WOMEN'S LONG SLEEVE BASEBALL T-SHIRT

- 100% cotton

» 2866023 | S-5X



WOMEN'S SHORT SLEEVE TEE

- Short sleeve gray baseball style tee with dark charcoal raglan contrast sleeve
- Screen print RZR logo on front
- 100% Cotton jersey knit
- 160 GSM

» 2866024 | S-3X



WOMEN'S LIFT QUARTER ZIP / NEW

- Blend of 92% polyester and 8% spandex
- Screen-printed RZR® logo
- Contrasting black body with "slash" pink lower sleeves

» 2866075 | XS-3X



WOMEN'S KAUMAJET HALF ZIP

- 85% polyester and 5% spandex blend
- 2-needle cover stitch at bottom, sleeves, and body
- Upper collar and center back neck embroidery
- Self-fabric neck taping center front to opposite center front

» 2865098 | S-2X



WOMEN'S FULL ZIP FLEECE

- 100% polyester
- Micro fleece

» 2866027 | Black/Pink | S-5X

» 2866028 | Blue/Purple | S-5X



WOMEN'S TECH QUARTER ZIP

- 92% Polyester
- 8% spandex

» 2866032 | XS-3X



WOMEN'S ASCENT FULL ZIP HOODIE / NEW

- 100% cotton bonded fleece knit hoodie
- Embroidered Polaris RZR® logo

» 2866077 | XS-3X



WOMEN'S CARVED SWEATSHIRT

- 100% cotton
- Fleece liner
- Shoulder zip

» 2866031 | S-3X



WOMEN'S RETRO HOODIE

- 95% cotton, 5% spandex
- French terry

» 2866030 | S-5X



WOMEN'S POWER FULL ZIP HOODIE / NEW

- 100% cotton hoodie in gray with lime colored zippers
- Vertical screened blue RZR® logo on front and blue collar snaps

» 2866078 | XS-3X



WOMEN'S DRIFT FULL ZIP HOODIE / NEW

- 100% cotton hoodie with bonded fleece knit
- Red overlaid with tonal "cracked" screen print
- Embroidered Polaris RZR® logo

» 2866076 | XS-3X



WOMEN'S CANYON HOODIE

- Embroidered RZR® logo on left chest
- Contrast zipper on left chest
- 100% Cotton, french terry

» 2865162 | S-3X



WOMEN'S ASYMMETRICAL HOODIE

- 95% cotton, 5% spandex
- French terry

» 2866033 | S-3X

USE THE BEST FOR YOUR MACHINE — PS-4 & POLARIS ENGINEERED LUBRICANTS™ - PG 80-81

CLEAN AND MEAN — VEHICLE CARE PRODUCTS - PG 79

TOOLS AT THE READY — PORTABLE WORKSTATION - PG 74

WRENCH AT ANY LEVEL — X3 CREEPER - PG 75

POWER UP — POLARIS POWER® INVERTER GENERATORS - PG 76

GET UNDER IT — VEHICLE LIFT - PG 75

STOCK THE GARAGE IN YOUR FAVOR

Parts, lubricants, tool chests, lifts and generators - Polaris® has all of the highest-quality products to keep your off-road vehicle running at peak performance.



"THE NEW POLARIS ENGINEERED™ VEHICLE CARE PRODUCTS ARE GAME CHANGERS. I RACE IN A DIRTY ENVIRONMENT AND USING MUD SHIELD IS THE ULTIMATE ADVANTAGE IN KEEPING THE CAR LIGHT AND THE SPONSORS ON THE SIDE HAPPY!"

— RJ ANDERSON POLARIS® OFF-ROAD RACER #37

TOOL CHESTS / NEW

READY TO WRENCH

If you've got a set of high-quality tools, keep them organized and protected in Polaris' line of premium tool chests and workstations. In the garage or in your vehicle - they go where you need them the most.

POLARIS® ROLLER TOOL CABINETS & CHESTS

- Raise and release drawer pulls keeps drawers secure when moving
- Drawers use roller bearing glides
- Full width wrap-around aluminum drawer pulls
- Tubular theft proof lock and keys



POLARIS® 30" 5-DRAWER ROLLER CABINET



POLARIS® 41" 11-DRAWER ROLLER CABINET

POLARIS® 30" 5-DRAWER ROLLER CABINET

- 30" W x 41" H x 20 1/2" D
- » 2830406 | Textured Finish

POLARIS® 41" 11-DRAWER ROLLER CABINET

- 41" W x 41 1/2" H x 18" D
- » 2830408 | Textured Finish
- » 2830451 | High Gloss Finish

POLARIS® 41" STANDARD TOP CHEST



POLARIS® 41" STANDARD TOP CHEST

- 40 1/2" W x 20 1/2" H x 19 1/2" D
- » 2830450 | High Gloss Finish



STACK THEM UP: For even more storage stack the Polaris 41" Standard Top or Workstation and Roller Cabinet together



POLARIS® 30" PORTABLE WORKSTATION

- 30" W x 20 1/2" H x 17 1/2" D
- 18-gauge steel construction
- Power tool rack with built-in power strip and 2 USB ports
- 35 wrench slots
- 186 socket pegs
- 48 driver holders
- Lockable lid
- Gas spring raises lid when unlatched for easy access

- » 2830405
- Tools not included



POLARIS® 41" PORTABLE WORKSTATION

- 41" W x 21 1/2" H x 17 1/2" D
- 16-gauge steel construction
- Power tool rack with built-in power strip and 2 USB ports
- 39 wrench slots
- 222 socket pegs
- 47 driver holders
- Socket tray lifts to access more tool storage underneath
- Lockable lid with double cut keys

- » 2830407
- Tools not included



POLARIS® HAND TOOL CADDY

- Heavy-duty steel finished in silver powder-coat
- Hangs from fence rail of roller tool cabinets
- Holds tools, rags, spray cans and more
- » 2830431
- Tools not included



POLARIS® POWER TOOL CADDY

- Heavy-duty steel finished in silver powder-coat
- Hangs from fence rail of roller tool cabinets
- Holds up to four power tools
- » 2830430
- Tools not included



POLARIS® BADGE

- Add RZR® or RANGER® badges to customize your roller cabinet or workstation
- » 2830412 | RZR®
- » 2830413 | RANGER®

CUSTOMIZE YOUR TOOL CHEST

WITH POLARIS® GRAPHIC PACKAGES
VIEW THEM ALL AT POLARIS.COM

SHOP PRODUCTS / NEW

POLARIS® VEHICLE LIFT

- Easily and safely lifts vehicles
- Operates using convenient foot pedal or lifts effortlessly with compressed air (approximately 125psi)
- Specifically designed to lift and secure off-road utility vehicles offering a tremendous safety advantage as opposed to the use of jacks and stands designed to lift and hold cars
- Positive dual locking safety catch
- » 2830424 | 1,250 lb.
- » 2830425 | 2,300lb.



POLARIS® VEHICLE LIFT ATTACHMENTS

- » 2830426 | Snowmobile Attachment
- » 2830427 | ATV/Polaris ACE® Attachment
- » 2830428 | RZR®/RANGER® Attachment



POLARIS® X3 CREEPER

- Sturdy steel frame construction
- Maximum 450 lb. working capacity
- 3 working positions: sit, recline and flat
- Ultra low flat position that is up to a full 2" lower than other creeper designs
- Six full-bearing, oil-resistant, solid PVC casters that are non-marking
- » 2830429



POLARIS® MAGNETIC PARTS TRAY

- Keeps nuts, bolts, fasteners and small tools within easy reach
- Soft, rubberized covering over magnets prevents damage to finished surfaces
- Corrosion resistant stainless steel tray
- 5.375" W x 9.365" L x 1.25" D
- » 2830432



POLARIS® 12" HI-TORQUE RATCHETING DRIVER

- Stainless steel shaft with fixed position tip
- Forward and reverse ratcheting action
- Rated up to 250 inch-pounds (35 kg/m) of torque
- Convenient bit storage inside handle
- Screwdriver bits made of S2 steel
- » 2830434



GREASE GUN KIT

- Tough steel construction and pistol grip design
- Front and top-pipe outlet mounts accept both 6" rigid pipe nozzle and 12" 12,000 psi flex hose
- Comes with standard zerk fitting
- » 2871312 | 4 case



POLARIS® LED POCKET FLASHLIGHT

- Bright 1 watt LED bulb generates 90 Lumens of light
- Capable of lighting up to 200-feet
- Includes two AAA Duracell® batteries
- » 2830436



POLARIS® 33" TELESCOPIC MAGNET

- Strong magnetic pick-up end
- Extends from 6.5" to 33"
- Up to 5-pounds of holding strength
- Features shielded side for targeted pickup
- Easy to grip Polaris® branded handle.
- » 2830435



POLARIS® SHOP TOWELS

- Durable blue shop towels work like cloth
- Contains 50% post consumer and industrial recycled fibers
- Ideal for medium to heavy duty cleaning
- » 2830402 | 200ct
- » 2830440 | 64ct
- » 2830403 | 200ct Refill
- 6 rolls per case



POLARIS® HEAVY DUTY SCRUBBER WIPES- 90CT

- Multipurpose cleaning towels with built-in solvent-free cleaning formula
- Removes grease, ink, tar, paint and more
- Conditions hands while it cleans with aloe, jojoba, wheat germ extract and vitamins
- Features a textured cleaning surface for really tough jobs
- Water rejuvenation extends life of towels
- » 2830441

PARTS

DO RIGHT BY YOUR MACHINE.

Polaris Engineered Parts™ are rigorously tested, developed specially for your machine and optimized for peak performance. Look to do right by your machine, so it will do right for you by using only Polaris Engineered Parts™.



AIR FILTERS

- In extreme stress tests, blocked 99.9% of dirt and contaminants
- Blocks 32% more dirt and contaminants than the closest competitor

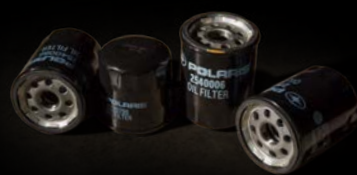

OIL FILTERS

- 44% less restriction than our competitors' oil filters, providing appropriate lubrication in any condition
- Designed to keep strong oil flow in the most demanding conditions
- Allows optimal oil flow for cold starts



BATTERY

- Designed, tested and improved to provide the high output needed in our high performance vehicles
- Guaranteed to fit in your machine & perform the way you demand it to



BRAKE PADS

- Designed and tested to perform in all conditions: humid, wet or dry, hot or cold
- Features sintered metallic pads to ensure optimal performance at extreme operating temperatures
- Engineered for maximum output and minimal noise and wear



DRIVE BELTS

- Lowest tolerance available (.188") means our belts have the least variation allowed in width and length, resulting in consistently higher performance
- All belts undergo at least 20,000 miles of vehicle testing and 1,500 hours of runtime in a dynamometer
- Made from Kevlar, our belts continue to perform and outlast other belts

2016 PARTS FIT CHART

VEHICLE	AIR FILTER	BELT	OIL FILTER	BATTERY	BRAKE PAD FRONT	BRAKE PAD REAR
RZR XP® TURBO EPS	» 1240957	» 3211186	» 2540086	» 4014132-P	» 2206231	» 2205949
RZR XP® 1000 EPS HIGH LIFTER EDITION	» 1240957	» 3211180	» 2540086	» 4014609	» 2205949	» 2205949
RZR XP® 1000 EPS / RZR XP® 1000 EPS 4 SEAT	» 1240957	» 3211180	» 2540086	» 4014132-P	» 2205949	» 2205949
RZR® S 1000 EPS	» 7082115	» 3211180	» 2540086	» 4014132-P	» 2206025	» 2203318
RZR® 900 / RZR® 900 EPS / RZR® S 900 / RZR® S 900 EPS	» 7082115	» 3211172	» 2540086	» 4014132-P	» 2206025	» 2203318
RZR® 900 EPS 4 SEAT	» 7082115	» 3211172	» 2540086	» 4014132-P	» 2205949	» 2203318
RZR® 570 EPS TRAIL BLACK PEARL	» 7081706	» 3211143	» 2540086	» 4010630	» 2203318	» 2202412
RZR® 570 EPS WHITE LIGHTNING	» 7081706	» 3211143	» 2540086	» 4012622	» 2203318	» 2202412

FOR A COMPLETE LISTING OF PARTS VISIT POLARIS.COM

FUEL TREATMENTS

PROVEN PERFORMANCE

PRODUCT	FUEL SYSTEM CLEANER	CORROSION PROTECTION	STABILIZES FUEL	COMBUSTION CLEANUP	ALCOHOL FREE
CARBON CLEAN	✓	✓	✓	✓	✓
ADVANCED FUEL TREATMENT		✓	✓		✓
AFTERMARKET 1					
AFTERMARKET 2	✓	✓			✓
AFTERMARKET 3					

Fuel treatments containing alcohol may be corrosive to critical engine components. All Polaris Engineered Lubricants™ fuel treatment products are alcohol free. Competitive products evaluated by third party testing facility using ASTM testing standards.



SCENTED ADVANCED FUEL TREATMENT / NEW

- New 1oz pouch treats 5 gallons of fuel
- Scented strawberry and mint formulas provide pleasant fragrance through the exhaust system
- Alcohol free: safe for all powersports applications
- Ethanol compatible
- » 2881419 | 25-1 oz. | Strawberry
- » 2881418 | 25-1 oz. | Mint
- » 2881420 | 25-1 oz. | Unscented
- » 2881421 | 75-1 oz. pouches | 3 Pack Kit - 25 each formula



CARBON CLEAN / NEW

- New advanced formula with 5:1 powersports treat ratio
- Ultimate fuel and injection system cleaner
- Removes carbon deposits from valves, piston rings, and combustion chamber
- Alcohol free: safe for all powersports applications
- Ethanol compatible
- » 2881413 | 12 oz. | 12 per case



ADVANCED FUEL / NEW TREATMENT

- New advanced formula with 5:1 powersports treat ratio
- Dual antioxidant formula protects jets and fuel system from gum and varnish
- Stabilizes fuel for up to 2 years
- Alcohol free: safe for all powersports applications
- Ethanol compatible
- » 2881416 | 12 oz. | 12 per case
- » 2881417 | 2.5 gal. | 2 per case

VEHICLE CARE

PRE-TREAT

MUD SHIELD™ PRE TREATMENT

- Pre-treat and protect, engineered for the most extreme conditions
- Makes cleaning your vehicle easier and faster
- Inhibits the adhesion of dirt, mud and snow
- » 2830229

NEVER RUST SPRAY™

- Brutal conditions demand superior protection, be prepared for any climate before and after you ride
- Synthetic formula protects against rust and corrosion while lubricating metal surfaces
- High resistance to water wash out
- » 2830230

CLEAN

XP WASH™

- Removed the most intense and stubborn dirt and trail build up easily
- A foaming, highly concentrated wash
- Superior water beading
- » 2830225

XP SPRAY WASH™

- Effortless cleaning power - simply spray on, spray off and go
- A biodegradable, high-performance wash ideal for removing dirt, oils and carbon build up
- » 2830224

GLASS CLEANER / NEW

- Heavy-duty foam formula clings to vertical surfaces
- Leaves an invisible, dirt resistant barrier for long lasting results
- Non-streak formula leaves glass surfaces crystal clear
- Cuts through grease, dirt, road-film and dried on bugs
- Cleans and brightens all glass surfaces
- » 2830443

ALL PURPOSE CLEANER

- Heavy-duty foam formula clings to vertical surfaces
- Leaves an invisible, dirt resistant barrier for long lasting results
- Non-streak formula leaves glass surfaces crystal clear
- Cuts through grease, dirt, road-film
- » 2830227

HD CLEANER & DEGREASER / NEW

- Professional grade formula
- Quickly dissolves and removes tough stains and soils from surfaces
- High foaming for optimum contact and penetration
- Biodegradable and contains no harsh acids
- » 2830418 | 1 gal.
- » 2830420 | 5 gal.

VEHICLE & EQUIPMENT WASH / NEW

- Professional grade formula
- Powers through vehicle buildup such as dirt, trail grime and grease
- Leaves a spot free rinse on all surfaces
- Concentrated formula treats up to 32 gallons
- Biodegradable
- » 2830417 | 1 gal.
- » 2830422 | 5 gal.

ALL PURPOSE CLEANER PLUS / NEW

- Professional grade formula
- Removes built up stains from shop floors, work benches and other hard surfaces
- All-purpose formula is VOC-free, environmentally friendly and biodegradable
- Contains no chlorine, phosphates, solvents or abrasive chemicals
- » 2830414 | 1 gal.
- » 2830416 | 5 gal.

SHINE

POLARIS® POLISH

- Protection and shine have never looked so good or been so easy - spray on, wipe off and go
- Ideal on painted and plastic surfaces
- Contains carnauba wax
- » 2830228

INSTANT SHINE & DETAILER

- Cleans, polishes and protects plastic and painted surfaces
- Be quick, be effective, be ready to go
- Spray and wipe formula
- » 2830226





THE ONLY OIL DEVELOPED WITH AND FOR YOUR ENGINE.

Only Polaris Engineered Lubricants™ are specially developed with Polaris® engines to handle the intense conditions and high-performance requirements demanded by riders worldwide. In independently verified testing, engines running for 75 hours, engines using PS-4 oil showed 24% less wear in crucial engine parts compared to traditional name-brand automotive oil, while consuming 19% less oil. Trust the only oil perfectly engineered for your Polaris® vehicle.

PS-4 FULL SYNTHETIC OIL

- Optimal ambient temperature operating range: -40° F to 100° F
- Maintains critical cold flow characteristics down to -40° F
- Designed specifically for Polaris® 4-cycle engines
- High film strength and wear protection under extreme loads and extreme cold temperatures
- Exclusive anti-wear additives protect engine parts
- Extra rust and corrosion protection



OIL CHANGE KITS

- » 2882166 POLARIS ACE® 570 MY 08-16, RZR®/RANGER® 570, TWIN 600, 700, 800
- » 2877473 SPORTSMAN® 330-570, XP 550/850/1000
- » 2880913 RANGER®/SPORTSMAN® ETX, POLARIS ACE™
- » 2879323 RANGER® XP 900, RZR® 900/1000
- » 2879129 RZR® XP MY11-12
- » 2881697 / **NEW** RZR® XP TURBO MY16

Contains the specific amount of oil for your machine, correct filter and mileage sticker



- » 2876244 | 1 qt. | 12 per case
- » 2877490 | 2 qt. | 8 per case
- » 2876245 | 1 gal. | 4 per case
- » 2876247 | 16 gal. drum
- » 2876246 | 55 gal. drum
- » 2878814 | 330 gal. tote

PS-4 EXTREME DUTY FULL SYNTHETIC OIL

- Optimal ambient temperature operating range: 0° F to 130° F
- Designed specifically for Polaris® 4-cycle engines
- High film strength and wear protection under extreme loads and extreme high temperatures
- Exclusive anti-wear additives protect engine parts
- Extra rust and corrosion protection



OIL CHANGE KITS

- » 2879004 POLARIS ACE® 570 MY 08-16, RZR®/RANGER® 570, TWIN 600, 700, 800
- » 2878924 SPORTSMAN® 330-570, XP 550/850/1000
- » 2879324 RANGER® XP 900, RZR® 900/1000
- » 2879130 RZR® XP MY11-12
- » 2881696 / **NEW** RZR® XP TURBO MY16

Contains the specific amount of oil for your machine, correct filter and mileage sticker



- » 2878920 | 1 qt. | 12 per case
- » 2878922 | 2 qt. | 8 per case
- » 2878919 | 1 gal. | 4 per case
- » 2879003 | 16 gal. drum
- » 2879002 | 55 gal. drum
- » 2879001 | 330 gal. tote

PS-4 FULL SYNTHETIC VS AUTOMOTIVE OIL

39% GREATER VISCOSITY RANGE

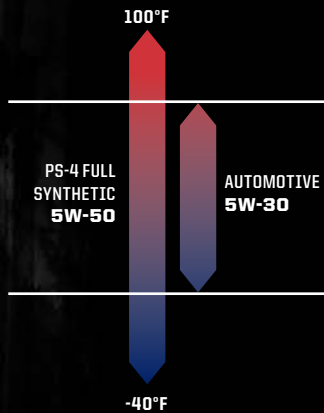

- Industry-leading viscosity range
- 5W provides optimal cold-start protection
- 50 provides maximum film strength in high-heat, high-stress conditions

24% BETTER WEAR PROTECTION



- Anti-wear additives bond to critical motor internals for wear prevention
- High detergency prevents sludge & carbon buildup

19% HIGHER OIL RETENTION



- Full synthetic base stock
- Low volatility keeps oil in the crankcase

TIP: FOR PEAK ENGINE PERFORMANCE & EXTENDED VEHICLE LIFE, REMEMBER TO CHANGE YOUR OIL EVERY 6 MONTHS*

*See owner's manual for your vehicles recommended maintenance interval.



ANGLE DRIVE FLUID

- Extreme pressure, anti-wear, high viscosity film lubrication
- Maximum protection of Polaris® front & right angle drives
- Excellent corrosion protection
- Ensures long component life under severe operating conditions

- » 2876160 | 1 qt. | 12 per case
- » 2872276 | 2.5 gal. | 2 per case



AGL

- Full synthetic friction-reducing formulation, extreme pressure film protection for severe operating temperatures
- Prevents rust, oxidation, foam and corrosion of internal ATV transmission components

- » 2878068 | 1 qt. | 12 per case
- » 2878069 | 1 gal. | 4 per case
- » 2878070 | 2.5 gal. | 2 per case
- » 2879594 | 55 gal.



DEMAND DRIVE

- Formulated for lubricity, corrosion and oxidation protection in all operating conditions
- Replaces Demand Drive Fluid, LT Demand Drive Fluid, and ADC Fluid

- » 2877922 | 1 qt. | 12 per case
- » 2877923 | 2.5 gal. | 2 per case



ORV MAINTENANCE KIT / NEW

- Kit includes:
 - 1.5 quarts of AGL
 - 1 quart of Angle Drive Fluid
 - 1 pint of Demand Drive Fluid
 - 1 3oz. tube of All-Season Grease
- Services RANGER®, RZR®, Sportsman®, Polaris ACE™

- » 2880425



EXTENDED LIFE ANTI-FREEZE 50/50 FORMULATION

- Extended 5-year service internal
- New organic acid technology
- Hard water compatible
- No scaling = better heat transfer
- New yellow coloration

- » 2880514 | 1 US qt. | 12 per case
- » 2880513 | 1 US gal. | 6 per case
- » 2880512 | 55 gal. drum



BRAKE FLUID

- Designed for use in Polaris® hydraulic brakes
- Superior high temperature characteristics
- Anti-corrosive additives extend the life of brake system and ensure consistent, positive braking

- » 2872189 | 12 oz. | 12 per case



SYNTHETIC DIESEL ENGINE OIL

- All-Season 5W-40 Formula
- Excellent cold weather protection
- Ultimate protection in heavy duty applications

- » 2879832 | 1 qt. | 12 per case



SUMMER 15W40 DIESEL OIL

- Multi grade lubricant designed for heavy duty equipment
- Excellent wear protection during high temperature applications

- » 2878473 | 2 qt. | 8 per case

LOCTITE®

- » 2830364 **LOCTITE® RED THREADLOCKER STICK HIGH STRENGTH**

- » 2830327 **LOCTITE® GASKET MAKER 518**

- » 2830362 **LOCTITE® 243 BLUE THREADLOCKER STICK MEDIUM STRENGTH**

- » 2830233 **LOCTITE® RTV 598 BLACK**

- » 2830236 **LOCTITE® THREAD SEALANT STICK**



GREASE GUN KIT

- Tough steel construction and pistol grip design
- Front and top-pipe outlet mounts accept both 6" rigid pipe nozzle and 12" 12,000 psi flex hose
- Comes with standard zerk fitting

- » 2871312 | 4 per case



ALL-SEASON GREASE

- High shear stability
- Superior adhesion
- Multi-purpose formulation for all Polaris® applications except U-joints
- Low temperature pliability for protection at cold start-up as well as excellent high speed and high temperature protection

- » 2871322 | 3 oz. 4-pack | 6 per case
- » 2871423 | 14 oz. | 10 per case



U-JOINT GREASE

- Increases U-joint life
- Extremely water resistant
- Molybdenum additive cushions shock-load in U-joint applications
- High shear stability
- Superior adhesion

- » 2871515 | 3 oz. 4-pack | 24 per case
- » 2871551 | 14 oz. | 10 per case



RAZOR SHARP PERFORMANCE NO MATTER THE TEMPERATURE.

Only Polaris Engineered Lubricants™ are developed with Polaris® engines to maximize the performance of your RZR® in extreme temperatures.

In addition to a full line of accessories and apparel, Polaris® offers a complete line of financing and service contract options. See your dealer for more info.

MY16 RZR Apprl Accessory Intl | 9930155

intl | 9930155



The only extended coverage straight from Polaris®—compromise nothing.
www.proctectmypolaris.com

All riders pictured are trained professionals. Polaris® recommends that all riders take a training course. Do not attempt maneuvers beyond your capability. Always wear a helmet and other safety apparel. Never drink and ride. All off-road vehicles depicted in this brochure may feature Polaris® parts and accessories and are not standard features of the base models they accompany. All performance and/or feature and benefit claims are based upon competitive data available at time of printing. For your nearest dealer, call 1-800-POLARIS or go to www.polaris.com.
Polaris Sales Inc., 2100 Hwy. 55, Medina, MN 55340 (763) 542-0500 Fax (763) 542-0599
Polaris Industries Ltd. 50 Prairie Way, Winnipeg, Manitoba, Canada R2J 3J8 (204) 925-7100 Fax (204) 925-7110

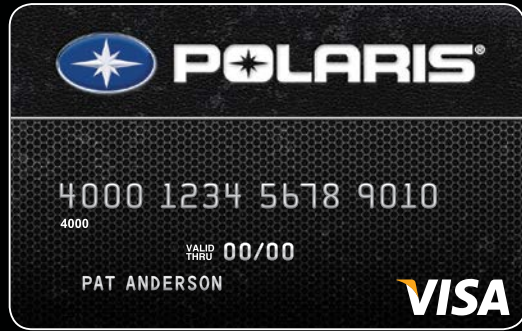

**EARN \$50 POLARIS® CASH
WITH YOUR FIRST PURCHASE
AND TAKE THE TRAIL MORE REWARDED.**



The creditor and issuer of the Polaris® Visa card is U.S. Bank National Association, pursuant to a license from Visa U.S.A. Inc. © 2015 U.S. Bank National Association. All rights reserved.

Unless noted, trademarks are the property of Polaris® Industries Inc. 509® is a registered trademark of 509, Inc. Amara® is a registered trademark of Kuraray Co. Ltd. of Japan. AP-360® is a registered trademark of TK. Bighorn® is a registered trademark of Cheng Shin Rubber USA, Inc. Bluetooth® is a registered trademark of Bluetooth Sig. Inc. Break-Up® is a registered trademark of Haas Outdoors, Inc. Browning® is a registered trademark of Browning Corporation. ChatterBox™ is a trademark of ChatterBox USA. Cordura® is a registered trademark of Invista North America S.A.R.L. Daewoo® is a registered trademark of Daewoo International Corporation. Fly F2® is a registered trademark of Western Power Sports, Inc. Fly Racing® is a registered trademark of Western Power Sports, Inc. FXR® is a registered trademark of Factory Racewear. iPhone® and iPod® are registered trademarks of Apple Computer, Inc. ITP® is a registered trademark of Carlisle Intangible Company. Jensen® is a registered trademark of Recoton Audio Corp. JL Audio® is a registered trademark of JL Audio, Inc. Kevlar® is a registered trademark of DuPont. Kolpin® is a registered trademark of Kolpin Outdoors, Inc. Lowrance® is a registered trademark of Navico, Inc. Lycra® is a registered trademark of INVISTA North America S.A.R.L. Maxxis® is a registered trademark of Cheng Shin Rubber Ind. Co., Ltd. Mossy Oak® is a registered trademark of Haas Outdoors, Inc. Nivomat® is a registered trademark of ZF Sachs AG. OBG10® is a registered trademark of Ogio International, Inc. PIAA® is a registered trademark of PIAA Corporation. Polyfil® is a registered trademark of J & P Coats Limited Corp. Quick-Dry® is a registered trademark of Innovative Fashion Group Corp. SAE® is a registered trademark of Society of Automotive Engineers, Inc. Sedona® is a trademark of Western Power Sports, Inc. Sirius® is a registered trademark of Ampspeaker APS Corporation. SIXR® is a trademark of Cheng Shin Rubber Ind. Co., Ltd. Snell® is a registered trademark of Snell Memorial Foundation, Inc. SSV WORKS® is a registered trademark of SSV Works, LLC. TekVest® is a registered trademark of Tekrider, Inc. Velcro® is a registered trademark of Velcro Industries B.V. Ltd Co. Netherlands. Walker Evans® is a registered trademark of Walker Evans Racing. WARN® is a registered trademark of WARN® Industries, Inc. YKK® is a registered trademark of YKK Corporation. Prices and availability are subject to change at any moment. Copyright © 2015 Polaris® Industries. All rights reserved.