

POLARIS
GENERAL



KEEP IT COLD.



SEE P. 20



MY19 GENERAL APP ACC EMEA

EMEA VERSION

POLARIS
GENERAL

2019

ACCESSORIES + APPAREL



ANY TASK. ANY TRAIL.



POLARIS
GENERAL

INDUSTRY LEADER

Combining unmatched power for off-road adventure and versatile features to take on any task and any trail.

2019 LINEUP

BASE

POLARIS GENERAL 1000



100 HP PROSTAR ENGINE
600 LB. DUMPING BOX
STANDARD HALF DOORS
ELECTRONIC POWER STEERING (EPS)
POLARIS LOCK & RIDE COMPATIBLE
VERSATRAC TURF MODE

PREMIUM

POLARIS GENERAL 1000 PREMIUM



BASE PLUS:
AUTOMOTIVE PAINT
MATTE BLACK CAST ALUMINUM WHEELS
27" MAXXIS CORONADO TIRES
SPORT LOW PROFILE FRONT BUMPER
POLARIS HD 4500 LB. WINCH

POLARIS GENERAL 1000 HUNTER EDITION



PREMIUM PLUS:
LOCK & RIDE DUAL GUN BOOT
2 POLARIS® GUN BOOTS BY KOLPIN®
POLARIS PURSUIT CAMO

POLARIS GENERAL 1000 LIMITED EDITION



ADDITIONAL FEATURES:
CUSTOM BREAKOUT CAMO GRAPHICS
COLOR MATCHED SPORT LOW PROFILE FRONT BUMPER
COLOR MATCHED ROCK SLIDERS

DELUXE

POLARIS GENERAL 1000 DELUXE



PREMIUM PLUS:
FOX PODIUM X 2.0 QS3 SHOCKS
SPORT ROOF
MTX PREMIUM SOUNDBAR
CONVEX REAR VIEW MIRROR
Now Available in Two Color Packages

POLARIS GENERAL 1000 RIDE COMMAND EDITION



DELUXE PLUS:
RIDE COMMAND 7" GLOVE-TOUCH DISPLAY
FRONT & REAR WIRED CAMERAS
GPS MAPPING
BLUETOOTH® PHONE CONNECTIVITY

4-SEAT

POLARIS GENERAL 4 1000



BASE PLUS:
AUTOMOTIVE PAINT
MATTE BLACK CAST ALUMINUM WHEELS
27" DIRT COMMANDER 8-PLY TIRES
FOX® PODIUM 2.0 QS3 SHOCKS
SPORT LOW PROFILE FRONT BUMPER
POLARIS HD 4500 LB. WINCH

POLARIS GENERAL 4 1000 RIDE COMMAND EDITION



BASE PLUS:
SPORT ROOF
MTX® PREMIUM 8 SPEAKER SOUNDBAR
RIDE COMMAND 7" GLOVE-TOUCH DISPLAY
FRONT & REAR WIRED CAMERAS
GPS MAPPING
BLUETOOTH® PHONE CONNECTIVITY
CONVEX REAR VIEW MIRROR

2019 POLARIS GENERAL ACCESSORIES

POLARIS ENGINEERED.....	02
WORK & EXPLORE.....	06
WINDSHIELDS & REAR PANELS.....	08
DOORS.....	10
ROOFS & PROTECTION.....	12
RIDE COMMAND, POLARIS PULSE, AUDIO & CAB ACCESSORIES.....	14
LIGHTING.....	16
STORAGE.....	18
POLARIS NORTHSTAR COOLER.....	20
WHEELS & TIRES.....	22
WINCHES & PLOWS.....	28
PARTS & GARAGE	
OIL & LUBRICANTS.....	30
MAINTENANCE.....	32
GARAGE & TRAILERING.....	36
APPAREL & HELMETS	
RIDING GEAR.....	38
CASUALWEAR.....	40

KEEP YOUR STANDARDS HIGH

DESIGNED

POLARIS OFFERS THE BROADEST LINEUP OF ACCESSORIES AND MOST INNOVATIVE SOLUTIONS IN OFF-ROAD. EACH ONE IS METICULOUSLY CRAFTED TO MATCH YOUR MACHINE.

EARLY DOOR RENDERING

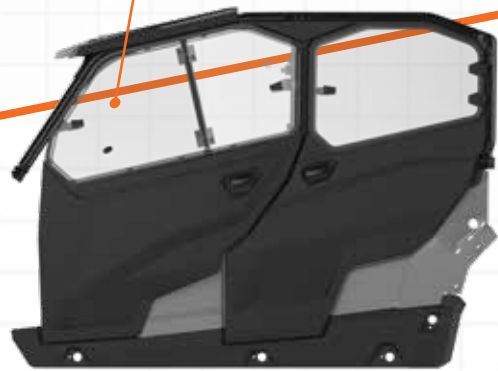

TESTED

BY THE TIME YOU GET THIS GEAR, PROTOTYPES HAVE GONE THROUGH HELL IN OUR LAB AND BEEN EXTENSIVELY TESTED IN THE FIELD. YOU RIDE WITH 100% CONFIDENCE.

TRUSTED

WE'VE EARNED RIDERS' TRUST OVER DECADES AND WE STAND BEHIND OUR WORK.

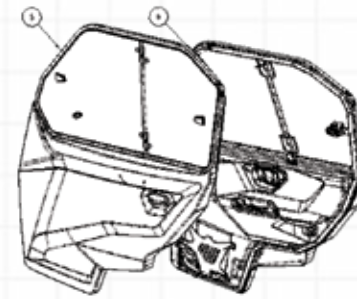

POLARIS PARTNERS WITH THE BEST

We choose our partners carefully, selecting only the best in off-road. Every accessory is rigorously tested and validated at Polaris standards, to ensure seamless integration and performance.



PRO ARMOR



WHEELS & TIRES P. 22
LED LIGHTS P. 16

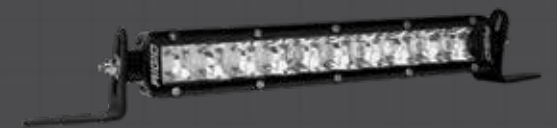

RIGID

LED LIGHTS P. 16

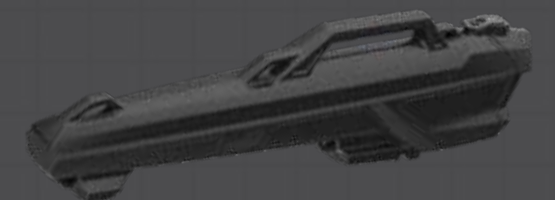

KOLPIN
OUTDOORS

ACCESSORIES P. 19

ENGINEERED TO TAKE ON **THE ELEMENTS**

TESTED & PROVEN



**POLARIS GENERAL CABS PROVIDE
THE INDUSTRY'S TIGHTEST SEAL**

11x

BETTER DUST SEAL

**BUILD YOUR CAB SYSTEM
STARTING ON P. 08**



**LUXURY
YOU HAVE TO
EXPERIENCE
TO BELIEVE**

Our cab components create an experience enhancing interior, offering supreme comfort to your vehicle.



PROFILE TUBE DESIGN

Contours built into the cage deliver the best sealing surface in the industry.



PERFECT FIT, PERFECT SEAL

A 360° gasket seal provides the tightest-sealing cab in the industry.



LOCK & RIDE

EASY ON & EASY OFF

Adapt to your needs and environment with exclusive tool-less, easy-on, easy-off Lock & Ride components.



NEW

PLUG & PLAY ELECTRICAL

**EFFORTLESSLY ADD
LIGHTS, HEAT, WIPERS & AUDIO.**

Be prepared for everything off-road riding & the elements throw at you.

A revolution in electrical accessory integration, the Polaris Pulse Electrical System allows for a simple plug & play approach for adding power to Polaris Engineered Accessories.

Look for  to identify Polaris PULSE ready accessories.

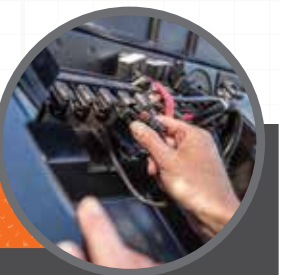
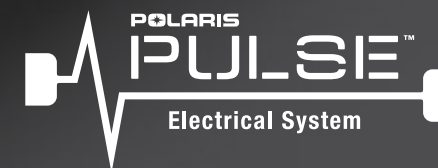

WORK FASTER



LOCK & RIDE
REAR PANEL - POLY
P. 09

SPORT ROOF - POLY
P. 12

LOCK & RIDE
CARGO BOX
P. 19

LOCK & RIDE
FULL WINDSHIELD POLY
P. 08

LOCK & RIDE
BED EXTENDER
P. 18

ZIP WINDOW
UPPER DOORS - CANVAS
P. 11

PRO ARMOR WHEEL & TIRE SET:
SIXR - MATTE BLACK &
DUAL-THREAT 29" TIRES
P. 23-27



LOCK & RIDE
FLIP-DOWN WINDSHIELD
- HARD COAT POLY
P. 08

PRO ARMOR DUAL ROW
76cm COMBO
P. 16-17

LOCK & RIDE
REAR PANEL - GLASS
P. 09

SPORT UPPER FRONT
BUMPER
P. 13

SPORT LOW
PROFILE FRONT BUMPER
P. 13

NEW
PREMIUM POLY FULL
DOOR, 4-SEAT
P. 10

POLARIS PRO HD
2041 kg WINCH
P. 28

RAPID ROPE RECOVERY
5x
FASTER

PRO ARMOR WHEEL & TIRE
SET: ATTACK 2.0 28" TIRES
& HALO MATTE BLACK
P. 23-27

EXTREME KICK-OUT
STEEL NERF BARS
P. 13

PREMIUM POLY FULL
DOOR, 2-SEAT
P. 10

EXPLORE FARTHER

SHIELD THE FRONT

CONTROL THE SWIRL

Keep the elements out of the cockpit. The multiple options allow you to choose and control the level of air flow into the cab.

Add a windshield to change the airflow around your vehicle. Turbulent air will form above the cargo bed and behind the cab. This swirl can carry dirt, dust, leaves, and rain into the cab. Eliminate this phenomenon and **control the swirl** by installing a rear panel.

- TIP-OUT WINDSHIELD - GLASS**
» 2881108
POLARIS GENERAL 4 '17-19,
POLARIS GENERAL '16-19
- LOCK & RIDE FULL WINDSHIELD - GLASS TOP SELLER**
» 2881109
POLARIS GENERAL 4 '17-19,
POLARIS GENERAL '16-19
- FLIP-DOWN WINDSHIELD - HARD COAT POLY**
» 2882174
POLARIS GENERAL 4 '17-19,
POLARIS GENERAL '16-19
- LOCK & RIDE FULL WINDSHIELD - HARD COAT POLY**
» 2881110
POLARIS GENERAL 4 '17-19,
POLARIS GENERAL '16-19
- LOCK & RIDE HALF WINDSHIELD - POLY**
» 2881111
POLARIS GENERAL 4 '17-19,
POLARIS GENERAL '16-19

- LOCK & RIDE REAR PANEL - GLASS TOP SELLER**
» 2881113
POLARIS GENERAL 4 '17-19,
POLARIS GENERAL '16-19
- LOCK & RIDE REAR PANEL - POLY**
» 2881112
POLARIS GENERAL 4 '17-19,
POLARIS GENERAL '16-19



TIP-OUT WINDSHIELD - GLASS



The three-position adjustment system easily opens, providing in-cab ventilation.

FLIP-DOWN WINDSHIELD - HARD COAT POLY



Offers fully-sealed or flipped-down venting options. Upper half detaches, leaving lower half for protection with maximum ventilation.

WINDSHIELD WIPER & WASHER SYSTEM



Add to wiper ready windshields for enhanced visibility in tough conditions.

2881090 See page 15



ADD A REAR PANEL TO REDUCE THE DUST SWIRL



Superior **OPTICAL CLARITY** for a clear view. Laminated safety glass **PROTECTS FROM SCRATCHES** and provides automotive-level visibility.

Curved to fit, seals tight, and is wiper ready.

Lightweight and flexible, POLY is **IMPACT-RESISTANT**, providing long-term value and protection. Guarantees a tight seal to keep out rain and dust.

Hard Coat options feature an extra layer on both sides of the poly, which provides **30x MORE** scratch resistance than regular poly windshields.

POLARIS ENGINEERED ADVANTAGES



AIRTIGHT GASKET SEAL

Our windshields and rear panels feature 360° airtight gasket seals to keep drafts and moisture out of your cab.



LOCK & RIDE

REVOLUTIONARY INSTALLATION

Windshields and rear panels install easily and lock securely in place using Polaris Lock & Ride technology. Once installed, it removes easily and can be reinstalled without the need for any tools.

COMPLETE YOUR CAB

11x BETTER
AT KEEPING DUST OUT



REPLACE EXISTING HALF DOORS WITH PREMIUM POLY FULL DOORS.

- Impact and scratch-resistant tempered glass
- Fully-sealed design keeps elements out for a premium in-cab environment

- Hinged window adjustability
- Soft-touch, easy to clean premium interior liner

FRONT

- Six-way glass window adjustability

» 2883717

POLARIS GENERAL 4 '17-19
POLARIS GENERAL '16-19

NEW REAR

- Push-out windows
- Kit includes B-pillar cover seal

» 2883082

POLARIS GENERAL 4 '17-19



POLARIS ENGINEERED ADVANTAGES



PREMIUM FEATURES

Automotive-like finish, cast handle, solid latches, storage and more.



A PERFECT FIT FOR THE PERFECT SEAL

Polaris Engineered cab components nest perfectly into the contours of the cab frame with a 360° degree gasket seal.

Polaris GENERAL comes equipped with half doors. To create an enclosed cab for increased protection from the elements, choose from two great Polaris options.



ADD ZIP WINDOW UPPER DOORS TO STOCK HALF DOORS

- Durable, rugged canvas stitched over a robust steel frame
- Lightweight, UV-resistant construction
- Retention straps for increased strength

- Zipper windows for increased venting options
- Mounts easily by drilling into stock doors (drill hole plugs included)

FRONT

» 2882548

POLARIS GENERAL 4 '18-19
POLARIS GENERAL '18-19

NOT SHOWN REAR

» 2883453

POLARIS GENERAL 4 '18-19

COVERAGE FOR YOUR CAB

Protect yourself from the elements. The right roof shields you from the sun and driving rain.

2-SEAT ROOFS

ROOF - ALUMINUM

- » 2881105
POLARIS GENERAL '16-19

PREMIUM ROOF - POLY

- » 2883800
POLARIS GENERAL '16-19

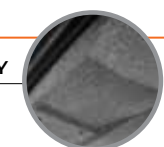

INCLUDES PREMIUM ROOF LINER

SPORT ROOF - POLY

- » 2883780
POLARIS GENERAL '16-19



4-SEAT ROOFS

NEW PREMIUM ROOF - POLY

- » 2883801
POLARIS GENERAL 4 '17-19

SPORT ROOF - POLY

- » 2883781
POLARIS GENERAL 4 '17-19



INCLUDES PREMIUM ROOF LINER



POLARIS ENGINEERED ADVANTAGES

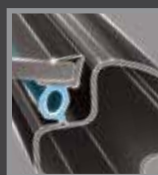

A PERFECT FIT FOR THE PERFECT SEAL

Polaris Engineered cab components nest perfectly into the contours of the cab frame with a 360° gasket seal.



PREMIUM FEATURES & QUIETER RIDE

Roof liners provide a clean look by hiding wiring, and absorb noise for a quieter ride.



KEEP MOISTURE MOVING

Keep precipitation moving with integrated channels that direct water away.

TAKE ON THE TERRAIN

Arm your Polaris GENERAL with Polaris Engineered bumpers and guards to take on any challenge. Engineered for easy, secure installation; providing added protection for lights, bodywork and suspension.

REAR BUMPERS

SPORT REAR BUMPER

- » 2881095
POLARIS GENERAL 4 '17-19,
POLARIS GENERAL '16-19



BUMPERS

A SPORT LOW PROFILE FRONT BUMPER

- » 2881094
POLARIS GENERAL 4 '17-19,
POLARIS GENERAL '16-19

B SPORT UPPER FRONT BUMPER

- » 2881525
POLARIS GENERAL 4 '17-19,
POLARIS GENERAL '16-19
Requires Sport Low Profile Front Bumper

A-ARM GUARDS

HMW A-ARM GUARDS - FRONT

- » 2880274
POLARIS GENERAL 4 '17-19,
POLARIS GENERAL '16-19

HMW A-ARM GUARDS - REAR

- » 2880171
POLARIS GENERAL 4 '17-19,
POLARIS GENERAL '16-19

ROCK SLIDERS / NERF BARS

LOW PROFILE STEEL ROCK SLIDERS

- » 2881102
POLARIS GENERAL '16-19

EXTREME KICK-OUT STEEL NERF BARS

- » 2-SEAT • 2881101
POLARIS GENERAL '16-19
- » 4-SEAT • 2881992
POLARIS GENERAL 4 '17-19



EXPANSION ANCHOR MOUNTS

TOUGH EXPANSION ANCHOR MOUNTS DESIGNED FOR POLARIS GENERAL ALLOW FOR QUICK INSTALL OF ROCK SLIDERS AND BUMPERS WITHOUT DAMAGING THE VEHICLE'S FRAME.

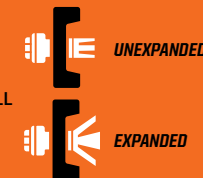

REVOLUTIONIZING THE OFF-ROAD EXPERIENCE

- TOTAL COMMAND CENTER FOR A WORLD OF CONNECTION AT YOUR FINGERTIPS
- BUILT IN GPS WITH TOPOGRAPHY MAPS TO SEE YOUR LOCATION AND PLAN YOUR RIDE
- MEDIA PLAYER W/ BUILT IN AM/FM TUNER FOR ALL YOUR FAVORITE MUSIC
- BUDDY TRACKING AND SHARE YOUR RIDE USING THE RIDE COMMAND MOBILE APP*
- HOLD A CONVERSATION WITHOUT SHOUTING AND SEE CALLS/TEXTS**

POLARIS
RIDECOMMAND

AVAILABLE IN FALL

RIDE COMMAND 7" DISPLAY



- 7" High Bright Touchscreen visible in all conditions
- Displays critical vehicle information for fuel level, coolant temp and battery voltage
- Media player w/ built in AM/FM tuner
- Buddy tracking and share your ride
- Dedicated shortcut buttons for quick access to features
- Bluetooth* and USB smart phone connectivity
- Front and rear camera support for better visibility on and off trail

» 2884002

POLARIS GENERAL 4 '19,
POLARIS GENERAL '19

AVAILABLE IN FALL

RIDE COMMAND MOUNT KIT



- Mount Ride Command seamlessly into the dash for perfect fit & finish
- Comes with wiring harnesses needed for Polaris GENERAL and accessory components
- Includes front & rear cameras

» WITH RIDE COMMAND
MTX® SOUNDBAR

» 2883803

POLARIS GENERAL 4 '17-19,
POLARIS GENERAL '16-19

» WITHOUT RIDE COMMAND
MTX® SOUNDBAR

» 2883804

POLARIS GENERAL 4 '17-19,
POLARIS GENERAL '16-19

*DOWNLOAD THE RIDE COMMAND® MOBILE APP



POLARIS ENGINEERED
ADVANTAGES

NEW INTRODUCING

POLARIS PULSE™
Electrical System



ELECTRICAL INSTALLS
MADE EASY WITH **PLUG & PLAY**

POLARIS PULSE IS A REVOLUTIONARY way to provide power to your vehicle, and makes adding electrical accessories a snap. Light bars, audio or other cab accessories are easier to install.

- To install accessories, simply plug the harness into the Polaris PULSE hub
- No need to remove nuts and stack wire terminals like a three-post terminal setup
- By plugging in your accessories, a secure connection is guaranteed every time

Look for **PULSE** to identify Polaris PULSE ready accessories.

THE FOLLOWING ACCESSORIES EASILY PLUG INTO THE FACTORY INSTALLED POLARIS PULSE UNDER THE HOOD:

- MTX® Premium Sound Bar *At right*
- 8-Vent Heater & Defrost System *At right*
- Windshield Wiper & Washer System *At right*
- All RIGID® & Pro Armor Light Bars *P. 16*

AVAILABLE IN FALL

NEW
POLARIS PULSE LED LIGHT BAR HARNESS

- Required to easily add electric components

» 2883785

POLARIS GENERAL 4 '19,
POLARIS GENERAL '19

CAB COMFORT



PULSE
MTX® PREMIUM SOUNDBAR

- Fully-sealed, injection-molded enclosure with marine-grade components
- 8 Speakers, 100-Watt
- Bluetooth* connections
- Not compatible with Ride Command (Need 2883803 Ride Command MTX® Soundbar with Mount Kit)

» 2881115

POLARIS GENERAL 4 '17-19,
POLARIS GENERAL '16-19



PULSE
8-VENT HEATER & DEFROST SYSTEM

» 2881316

POLARIS GENERAL 4 '17-19,
POLARIS GENERAL '16-19



PULSE
WINDSHIELD WIPER & WASHER SYSTEM

» 2881090

POLARIS GENERAL 4 '17-19,
POLARIS GENERAL '16-19



PULSE
CONVEX REAR VIEW MIRROR

» 2881540

POLARIS GENERAL 4 '17-19,
POLARIS GENERAL '16-19



PULSE
AVAILABLE IN FALL
MULTI-FUNCTION CAB LIGHT

- Multi-color functionality
- Removable to use as flashlight

» 2884047

POLARIS GENERAL 4 '19,
POLARIS GENERAL '19

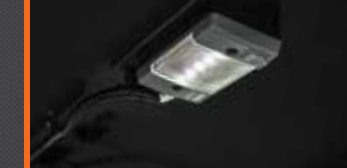

» 2879270

POLARIS GENERAL 4 '17-18,
POLARIS GENERAL '16-18

Not compatible with 2881105 Roof



PULSE
FLOOR MATS

» 2881934

POLARIS GENERAL 4 '17-19,
POLARIS GENERAL '16-19



POLARIS REMOTE GARAGE DOOR OPENER BY HOMELINK®

» 2882082

POLARIS GENERAL 4 '17-18,
POLARIS GENERAL '16-18

**Requires in-helmet communication.

ACCESSORIES

WINDSHIELDS & REAR PANELS

DOORS

ROOFS & PROTECTION

TECH, AUDIO & LIGHTING

STORAGE & COOLERS

WHEELS & TIRES

WINCHES & PLOWS

RIGID

POLARIS ENGINEERED
ADVANTAGES

DESIGNED
to mount perfectly to your Polaris Engineered bumper,
roof or other mounting point

TESTED
for maximum
performance

TRUSTED
to not overtax
your machine

PRO ARMOR



ADVANCED TECH

RIGID® lights are driven by Aluminum PCB Smart Boards™, 6063-T5 aircraft aluminum extruded housings and Tiger Drylac® UV protection polyester powdercoating.

EXCLUSIVE OPTICS

RIGID® invests heavily in optical science and has patented multiple optics and optics systems, maximizing light output and efficiency.

ECE CERTIFIED

RUGGED CONSTRUCTION

Pro Armor lights are designed to be big and beefy with an aggressive style all their own, and housed in IP67 marine-grade rated UV polyester powdercoating.

MASSIVELY BRIGHT

Pro Armor builds bright lights designed for any riding experience. All that power is directed through heat dissipating aluminum for streamlined heat management.

ECE CERTIFIED

LIGHT BAR TYPES



SR-SERIES PRO

Sleek, powerful, low-profile (under 5 cm tall). Lights extreme distances with low energy usage. Available in 25.4 cm & 81.3 cm



D-SERIES PRO

Compact to fit almost anywhere with high output and low energy usage. Available in Driving, Flood & Spot



DUAL-ROW LED LIGHT BARS

The most spread and farthest illumination downrange. Easy to mount. Available in Cube, 25.4 cm, 50.8 cm & 76.2 cm



SINGLE-ROW LED LIGHT BARS

Powerful, compact, low-profile light bars with sleek look. Available in 27.9 cm, 83.8 cm & 101.6 cm



CUBE LED LIGHTS

Small size allows mounting in strategic locations for added lighting. Available in Flood & Spot

LIGHT BAR OPTIONS

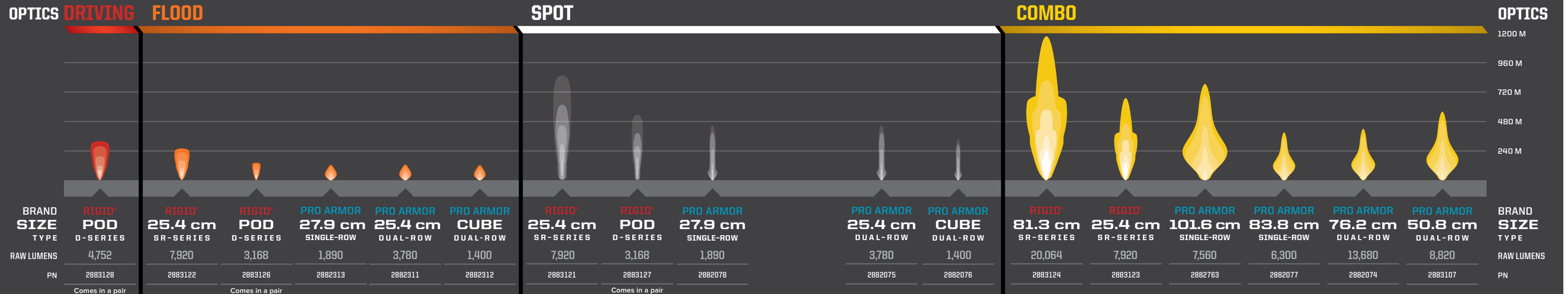

BUILD YOUR VISION

Consider the Optics, Angle & how you will use your vehicle to choose the right light or set of lights.

OPTICS LIGHT ANGLE	ACCENT	DRIVING (45°)	FLOOD (25°)	SPOT (10°)	COMBO (25°/10°)
DRIVING SPEED	All	Slow	Medium	Fast	Medium to Fast
BEAM	Diffused glow	Extra-wide	Wide/Shorter	Concentrated/Long	Inner Spot & Outer Flood
RECOMMENDED MOUNTING	Low/Wheel well	All points	Low &/or rear	High points	All points
TERRAIN & RIDING STYLE	Added style & personalization in any terrain	All riding & utility	Wide-open terrain or trails & utility	Trail & tight conditions	All riding & utility

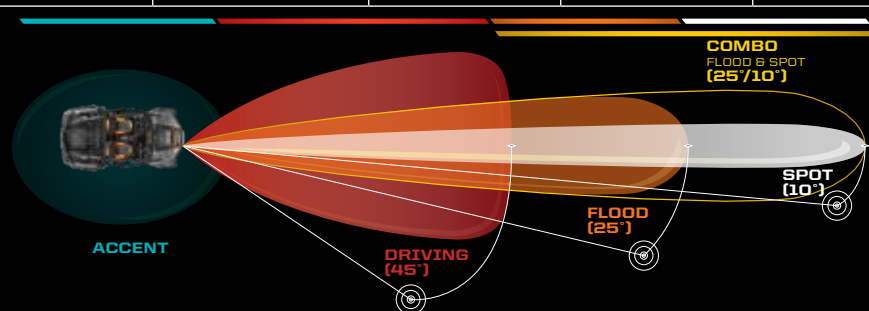

ADD A HARNESS TO MOUNT YOUR LIGHTS

MODEL	LIGHT BAR SET-UPS		
	1 LIGHT IN 1 LOCATION ON 1 SWITCH	2 LIGHTS IN 2 LOCATIONS ON 1 SWITCH	2 LIGHTS IN 2 LOCATIONS ON 2 SWITCHES
2014-2018 ALL MODELS	LIGHT BAR HARNESS 2883486	LIGHT BAR HARNESS 2883486 Y-HARNESS 2879860	LIGHT BAR HARNESS 2881678
2019 ALL MODELS	NEW POLARIS PULSE LED LIGHT BAR HARNESS 2883785	NEW POLARIS PULSE LED LIGHT BAR HARNESS 2883785 Y-HARNESS 2879860	NEW POLARIS PULSE LED LIGHT BAR HARNESS (x2) 2883785

▲ No battery connection cables required on any model/model year Polaris GENERAL®.

▲ All Rigid® and Pro Armor lights are Polaris Pulse ready.

TRAILBLAZER LED HEADLIGHTS

- Adjustable beam pattern (outer two lights) from spot to flood
- Integrated LED daytime running light
- 6,000 Lumen total output; 20-watt CREE® XHP LED Chips
- Waterproof, dustproof, fade resistant

» BLACK BEZEL • 2882073
Polaris general 4 '17-18,
Polaris general '16-18

TRAILBLAZER HEADLIGHT COLORED BEZEL

POLARIS GENERAL 4 '17-19,
POLARIS GENERAL '16-19

COLOR	2-PACK
RED	2882479-293
WHITE	2882479-133
RAW	2882479
BLUE	2882479-689

ACCENT LIGHTING

ACCENT LIGHTS

POLARIS GENERAL 4 '17-19,
POLARIS GENERAL '16-19

COLOR	PN
RED (SET OF 4)	2880500
BLUE (SET OF 4)	2880506
RED (SINGLE)	2880532
BLUE (SINGLE)	2880533

ACCESSORIES

WINDSHIELDS & REAR PANELS

DOORS

ROOFS & PROTECTION

TECH, AUDIO & LIGHTING

STORAGE & COOLERS

WHEELS & TIRES

WINCHES & PLOWES

LOCK AND LOAD IT

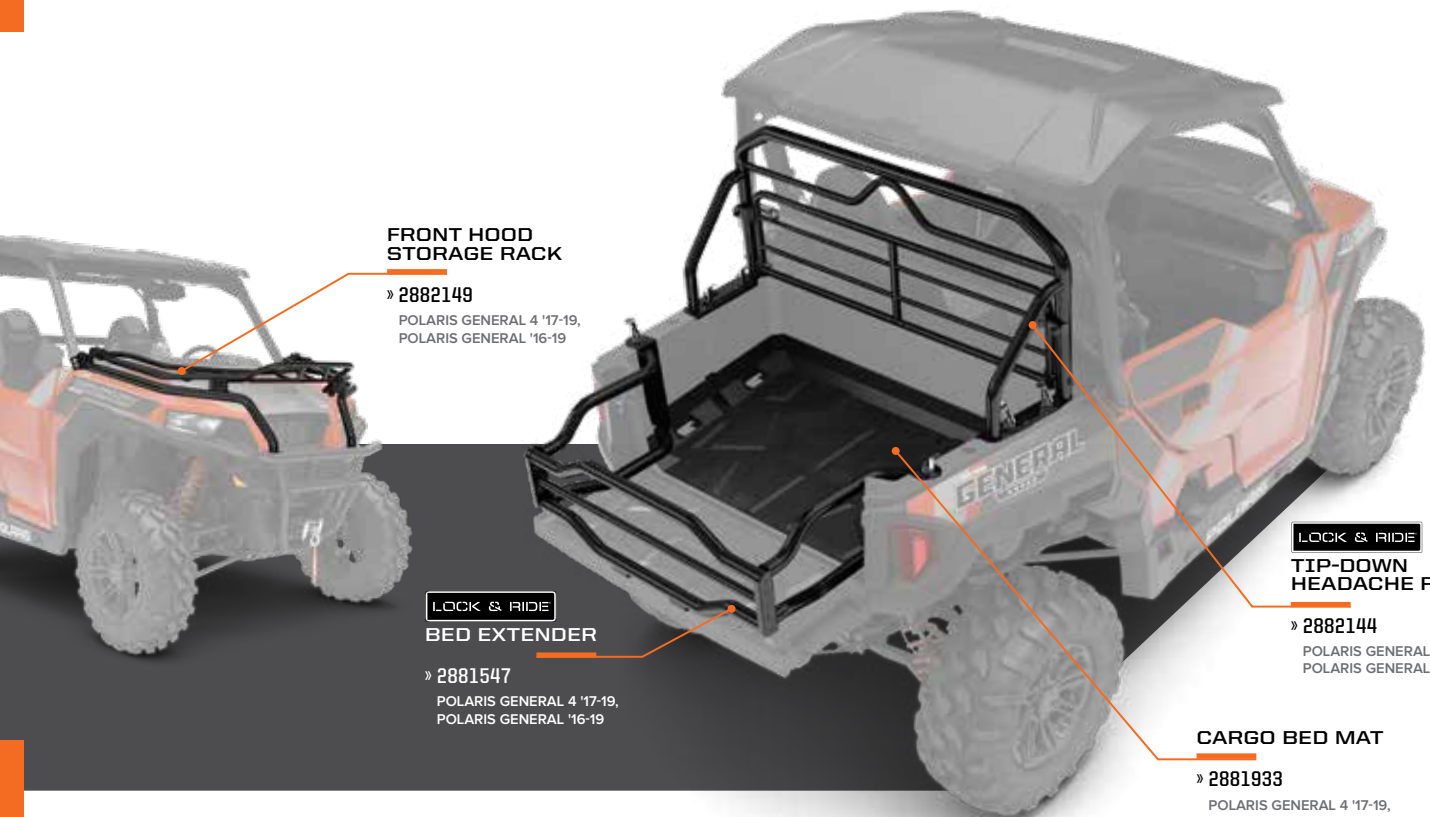

FRONT HOOD STORAGE RACK

» 2882149
POLARIS GENERAL 4 '17-19,
POLARIS GENERAL '16-19

LOCK & RIDE BED EXTENDER

» 2881547
POLARIS GENERAL 4 '17-19,
POLARIS GENERAL '16-19

LOCK & RIDE TIP-DOWN HEADACHE RACK

» 2882144
POLARIS GENERAL 4 '17-19,
POLARIS GENERAL '16-19

CARGO BED MAT

» 2881933
POLARIS GENERAL 4 '17-19,
POLARIS GENERAL '16-19



LOCK & RIDE SPARE TIRE CARRIER

» 2881529
POLARIS GENERAL 4 '17-19,
POLARIS GENERAL '16-19



BEHIND SEAT STORAGE BAG

» 2882164
POLARIS GENERAL '16-19



IN-DASH STORAGE BAG

» 2882165
POLARIS GENERAL 4 '17-19,
POLARIS GENERAL '16-19

FIRE EXTINGUISHER HOLDER (NOT SHOWN)

» 2882158
POLARIS GENERAL 4 '17-19,
POLARIS GENERAL '16-19
Fits most 3.25" fire extinguishers
(not included)

POLARIS ENGINEERED ADVANTAGES



LOCK & RIDE

REVOLUTIONARY INSTALLATION

Available on all Polaris vehicles, Lock & Ride accessories allow for a quick reconfiguration between work and adventure. With the flip of a lever, Lock & Ride plungers use downward pressure to expand for a secure fit.

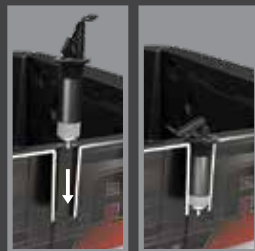

Ample storage with multiple openings for ease & convenience

LOCK & RIDE CARGO BOX

» 2881527
POLARIS GENERAL 4 '17-19,
POLARIS GENERAL '16-19

LOCK & RIDE D-RINGS

» 2881545
POLARIS GENERAL 4 '17-19,
POLARIS GENERAL '16-19

STRAP OPTIONS

P. 21



KOLPIN OUTDOORS

PROTECT THE GEAR YOU NEED.
LIVE THE LIFE YOU LOVE.



We would like to thank our partners Browning® and Mathews® for helping to deliver a successful and safe off-road experience when out in the field.



KOLPIN STRONGHOLD® MOUNT

LOCK & RIDE KOLPIN STRONGHOLD® AUTO-LATCH DOUBLE BOOT MOUNT

» 2883970
POLARIS GENERAL 4 '17-19,
POLARIS GENERAL '16-19

KOLPIN STRONGHOLD® CASES

KOLPIN STRONGHOLD® GUN BOOTS

» XL TRANSPORT • 2882430*
POLARIS GENERAL 4 '17-19,
POLARIS GENERAL '16-19

» L IMPACT • 288242*
POLARIS GENERAL 4 '17-19,
POLARIS GENERAL '16-19

KOLPIN STRONGHOLD® PISTOL BOOT

» 2882429*
POLARIS GENERAL 4 '17-19,
POLARIS GENERAL '16-19

KOLPIN STRONGHOLD® ICE ROD BOOT

» 2882428*
POLARIS GENERAL 4 '17-19,
POLARIS GENERAL '16-19

KOLPIN STRONGHOLD® ICE AUGER/ POP-UP BLIND BOOT

» 2882427*
POLARIS GENERAL 4 '17-19,
POLARIS GENERAL '16-19

*REQUIRES AUTO-LATCH MOUNT (2883970 OR 2884106)



KOLPIN RHINO GRIPS® IDEAL FOR BOWS & UNCASSED GUNS



LOCK & RIDE RATCHETING RHINO GRIP®

» 2881575
POLARIS GENERAL 4 '17-19,
POLARIS GENERAL '16-19



LOCK & RIDE RHINO GRIP® XL

» 2881574
POLARIS GENERAL 4 '17-19,
POLARIS GENERAL '16-19



RHINO GRIP® XL REPLACEMENT RUBBER STRAPS

» 2881621
POLARIS GENERAL 4 '17-19,
POLARIS GENERAL '16-19



LOCK & RIDE RHINO GRIP® PRO

» 2884107
POLARIS GENERAL 4 '17-19,
POLARIS GENERAL '16-19



LOCK & RIDE RHINO GRIP® XL DOUBLE

» 2884108
POLARIS GENERAL 4 '17-19,
POLARIS GENERAL '16-19

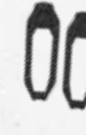

RHINO GRIP® PRO RUBBER STRAPS

» 2884109
POLARIS GENERAL 4 '17-19,
POLARIS GENERAL '16-19

KEEP IT ICE COLD



POLARIS NORTHSTAR COOLERS can survive just about anything - from extreme heat to a nasty tumble off a vehicle. So when we say ice will stay cold for hours on end and anything inside will stay locked up tight, we mean it.

POLARIS NORTHSTAR® COOLER



- | | | | | |
|---|---|---|--|--|
| 99 LITER
» GRAPHITE • 2883426
» DESERT • 2883392 | 57 LITER
» GRAPHITE • 2883425
» DESERT • 2881259 | 28 LITER
» GRAPHITE • 2883424
» DESERT • 2881315 | 14 LITER <i>NEW</i>
» GRAPHITE • 2883968 | 19 LITER SOFTSIDE
» GRAPHITE • 2883390 |
|---|---|---|--|--|

28, 57 & 99 LITER FEATURES

- ComfortCarry Handles
- TravelLock System
- EasyOut Drain System
- NoSlip Rubber Feet
- PolarWall Insulation 5 cm
- IceLock Seal

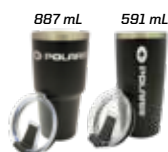

TUMBLERS

- » 887 mL • 2883394
- » 591 mL • 2883393

GRIZZLY TESTED. POLARIS APPROVED.



This cooler is IGBC-approved, meaning it withstands the power expended by a typical grizzly bear if it was trying to get inside. Seriously, there are experts who know what a grizzly is capable of doing, and they certify that the Polaris Northstar Cooler can take it.



POLARIS NORTHSTAR® COOLER ACCESSORIES



WIRE BASKET

- » 99 LITER • 2883648 *NEW*
- » 57 LITER • 2882185
- » 28 LITER • 2882438



DIVIDERS

- » 99 LITER • 2883468 *NEW*
COMES WITH ONE DIVIDER
- » 57 LITER • 2882184
COMES WITH TWO DIVIDERS
- » 28 LITER • 2882186
COMES WITH ONE DIVIDER
Divider doubles as a cutting board



SEAT CUSHION

- » 57 LITER • 2882179
- » 28 LITER • 2882507

COOLER WHEELS

- » 57 LITER • 2882180

BOTTLE OPENER

- » 2882183
ALL COOLERS



LOOK & HIDE QUICKSTRAP

- » 2882187
ALL COOLERS AND POLARIS GENERAL CARGO BOXES



NEW 3.8 cm x 4.6 m 2495 kg RATCHET STRAP

- Heavy duty webbing
- 2495 kg Maximum Load / 831 kg Working Load
- 2 Pack
- » 2884031



NEW 5.1 cm x 6.1 m 4536 kg RATCHET STRAP

- Heavy duty webbing
- 4536 kg Maximum Load / 1497 kg Working Load
- Floating D-Rings
- Double J-Hooks
- » 2884032

PRO ARMOR

Each wheel and tire Pro Armor designs for off-road vehicles performs perfectly in the intended environment for its intended use. Developed, tested, and produced in partnership so you can tackle the terrain ahead with Polaris.

TRIPLE-BELTED SIDEWALLS

- Sidewalls are the most vulnerable puncture area of any off-road tire
- Pro Armor makes tires with extra protection exactly where it's needed most - the sidewall

8 OR 10-PLY RATED

- Pro Armor builds the toughest tires
- Higher ply ratings mean added protection

INNOVATION

DUAL DUROMETER LUGS (Crawler XG & Attack 2.0)

- Firm durometer rubber on base of lug for stability
- Soft durometer rubber on top of lug for sticky grip

DUAL COMPOUND TREAD (Dual-Threat)

- Firm durometer rubber on center of tread for long wear life
- Soft durometer rubber on shoulders of tread for superior grip

4,828+ km RATED

Pile on the kilometers with Pro Armor tires. Every tire is designed and constructed with longevity in mind. With ratings of and beyond, you are assured long life and performance.

KNOW YOUR TIRES

DIMENSIONS	TREAD DEPTH	WEIGHT	PLY RATING	SIDEWALL BELTS	LOAD RATING
28" x 9" R14 <small>TIRE HEIGHT TIRE WIDTH WHEEL DIAMETER</small>	A deeper tread means more grip in all conditions	A lighter tire makes for improved vehicle performance	Indicates tire puncture-resistance	Increase your resistance to sidewall punctures	Tires with higher load ratings can handle more weight



BACKCOUNTRY/TRAIL



PRO ARMOR DUAL-THREAT

- Dual-compound technology and radial construction offer performance in all terrains
- Softer durometer rubber on outer edge for overall superior grip and feel
- Harder durometer rubber in the middle for increased traction during acceleration and longer tread life

		TREAD DEPTH	TIRE WEIGHT	PLY RATING	SIDEWALL BELTS	LOAD RATING
14"	26" x 9" R14 5416340	FRONT	12 kg	10	3	413 kg
14"	26" x 11" R14 5416341	REAR	14 kg			503 kg
14"	29" x 9" R14 5416342	FRONT	14 kg			503 kg
14"	29" x 11" R14 5416343	REAR	16 kg			599 kg

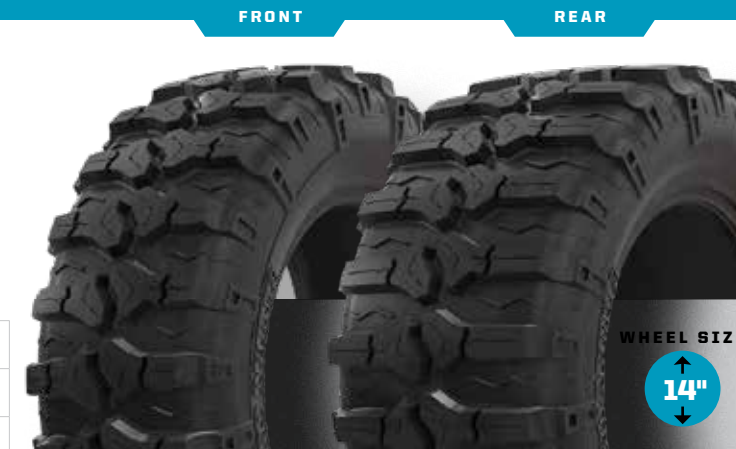

DUAL-COMPOUND = MORE GRIP + LONGER LIFE

Firmer Durometer Rubber = Longer Life

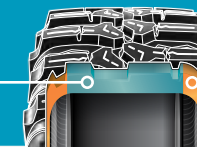

Softer Durometer Rubber = More Grip



PRO ARMOR ATTACK 2.0

- Engineered for excellent hard-pack performance
- Dual-compound technology and radial construction offer performance in all terrains
- Tight thread pattern for a quieter ride

		TREAD DEPTH	TIRE WEIGHT	PLY RATING	SIDEWALL BELTS	LOAD RATING	
15"	28" x 10" R15 5416344	FRONT/REAR	25mm	15 kg	8	3	503 kg



PRO ARMOR ATTACK

- The best all-purpose tire for all-season traction in any terrain
- Unique, full-face tread design
- Harder durometer lugs promote extended wear, increasing tire life
- Wider spaced lugs provide more grip in softer terrain

		TREAD DEPTH	TIRE WEIGHT	PLY RATING	SIDEWALL BELTS	LOAD RATING
14"	26" x 9" R14 5415613	FRONT	13 kg	8	3	413 kg
14"	26" x 11" R14 5415614	REAR	15 kg			599 kg



ATTACK 2.0 VS. ATTACK

- **Tighter Tread Pattern** = Better traction in hard pack
- **Dual-Durometer Lug** = Increased grip & traction in rough terrain, smoother ride in all terrain
- **10-Ply Rated** = increased durability
- **Larger Size Offering in 28"** = more ground clearance & trail traction



MUD



FRONT

REAR

PRO ARMOR DAGGER

- From the trails to the pits, this tire gets you through it all
- Deep, self-cleaning lug and wide tire design for exceptional mud pit performance
- Rounded profile and full lug pattern for on-trail comfort

			TREAD DEPTH	TIRE WEIGHT	PLY RATING	SIDEWALL BELTS	LOAD RATING
14"	27" x 9" R14 5415617	FRONT	38mm	15 kg	8	3	503 kg
14"	27" x 11" R14 5415618	REAR		18 kg			531 kg



WHEEL SIZE

14"

ROCK



FRONT / REAR

PRO ARMOR CRAWLER XR

- Wanna race? This tire grips it all from the trail to the rocks
- Square block profile for even surface contact
- A tougher durometer than the XG to take on the toughest the trail has to offer

			TREAD DEPTH	TIRE WEIGHT	PLY RATING	SIDEWALL BELTS	LOAD RATING
14"	28" x 10" R14 5415536	FRONT/REAR	16mm	15 kg	8	3	517 kg



WHEEL SIZE
14"

XR

SINGLE DUROMETER

- Smaller lug height and single durometer gives this high-speed tire added rigidity and lateral stability when cornering
- Unique lug design excels in hard-packed, fast terrain



WHAT CRAWLER ARE YOU?



FRONT / REAR

PRO ARMOR CRAWLER XG

- Big or small, these tires crawl them all
- A soft, sticky compound makes this tire ideal for both rock crawling and desert running
- 8-ply, triple-belted ballistic sidewalls resist punctures

			TREAD DEPTH	TIRE WEIGHT	PLY RATING	SIDEWALL BELTS	LOAD RATING
15"	28" x 10" R15 5416346	FRONT/REAR	20mm	15 kg	8	3	503 kg



WHEEL SIZE
15"

XG

DUAL-DUROMETER

- Taller lug height and dual-durometer construction
- Perfect balance between high-speed performance, durability and flex in order to grip slick rock



UTILITY

FRONT / REAR

FRONT / REAR

FRONT / REAR



WHEEL SIZE
14" 12"



PRO ARMOR HARVESTER

- All-around work horse with tread life of 5,000 miles
- Tread pattern designed to withstand anything from the farm yard, to the pastures to the trail
- With 10-Ply it can carry the load day-in and day-out

- 14" **28" x 10" R14** • FRONT/REAR • 5416347
- 27" x 10" R14** • FRONT/REAR • 5415965
- 12" **26" x 8" R12** • FRONT • 5416396
- 26" x 10" R12** • REAR • 5415966

			TREAD DEPTH	WEIGHT	PLY RATING	SIDEWALL BELTS	LOAD RATING
26R12	FRONT	16mm	13 kg	10	3	3	388 kg
	REAR						615 kg
27R14	FRONT/REAR	16mm	15 kg	10	3		599 kg
28R14	FRONT/REAR		15 kg				630 kg



WHEEL SIZE
14" 12"



PRO ARMOR PRESERVE

- 5,000-mile tread life
- Turf-friendly for areas where low-impact tire tread is needed
- Rounded profile and special tread pattern to limit footprint

- 14" **27" x 10" R14** • FRONT/REAR • 5416348
- 12" **26" x 8" R12** • FRONT • 5416403
- 26" x 10" R12** • REAR • 5416402

			TREAD DEPTH	WEIGHT	PLY RATING	SIDEWALL BELTS	LOAD RATING
26R12	FRONT	16mm	13 kg	10	3	3	388 kg
	REAR						599 kg
27R14	FRONT/REAR		13 kg				599 kg



WHEEL SIZE
12"



PRO ARMOR XD-K

- 26" Aramid fiber-belted tire to tackle any terrain
- Unique full-face tread design
- Harder durometer lugs promotes for extended wear increasing tire life

- 12" **26" x 9" R12** • FRONT • 5415756
- 26" x 11" R12** • REAR • 5415757

			TREAD DEPTH	WEIGHT	PLY RATING	SIDEWALL BELTS	LOAD RATING
FRONT	31.7mm	8	13 kg	3/1 Aramid	3	3	388 kg
							REAR

WHEELS

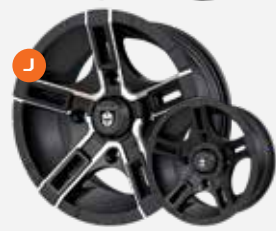
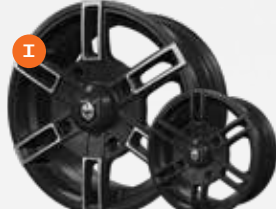
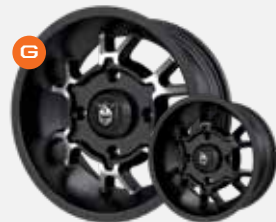
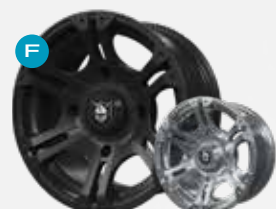
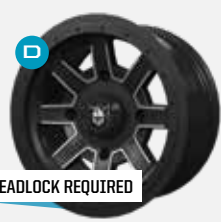
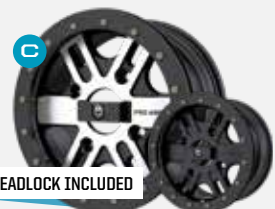

14"

15"

BEADLOCK REQUIRED

BEADLOCK INCLUDED

A AMPLIFY

FRONT WEIGHT: 5.9 kg | **LOAD RATING:** 408 kg | **OFFSET:** -9
REAR WEIGHT: 6.4 kg | **LOAD RATING:** 590 kg | **OFFSET:** +4
ACCENT: FRONT 14" x 7" • 1522956-266
 REAR 14" x 8" • 1522957-266
MATTE BLACK: FRONT 14" x 7" • 1522956-458
 REAR 14" x 8" • 1522957-458

B BUCKLE

FRONT WEIGHT: 5.8 kg | **LOAD RATING:** 408 kg | **OFFSET:** +4
REAR WEIGHT: 6.1 kg | **LOAD RATING:** 590 kg | **OFFSET:** -9
ACCENT: FRONT 14" x 7" • 1522544-266
 REAR 14" x 8" • 1522545-266
MATTE BLACK: FRONT 14" x 7" • 1522544-458
 REAR 14" x 8" • 1522545-458

C COMBAT (BEADLOCK RINGS INCLUDED)

WEIGHT: 7.3 kg | **LOAD RATING:** 729 kg | **OFFSET:** +38
ACCENT: 14" x 7" • 1523283
MATTE BLACK: 14" x 7" • 1523284

D REBLR (REQUIRES BEADLOCK RINGS)

FRONT WEIGHT: 5.9 kg | **LOAD RATING:** 408 kg | **OFFSET:** +4
REAR WEIGHT: 6.6 kg | **LOAD RATING:** 590 kg | **OFFSET:** -9
ACCENT: FRONT 14" x 7" • 1522238-458
 REAR 14" x 8" • 1522239-458

E SHACKLE

FRONT WEIGHT: 5.9 kg | **LOAD RATING:** 408 kg | **OFFSET:** +4
REAR WEIGHT: 6.4 kg | **LOAD RATING:** 590 kg | **OFFSET:** -9
ACCENT: FRONT 14" x 7" • 1522546-266
 REAR 14" x 8" • 1522547-266
MATTE BLACK: FRONT 14" x 7" • 1522546-458
 REAR 14" x 8" • 1522547-458

F SIXR

FRONT WEIGHT: 4.8 kg | **LOAD RATING:** 408 kg | **OFFSET:** +4
REAR WEIGHT: 5.7 kg | **LOAD RATING:** 590 kg | **OFFSET:** -9
MATTE BLACK: FRONT 14" x 7" • 1521507-521
 REAR 14" x 8" • 1521508-521
LUSTER: FRONT 14" x 7" • 1521507-410
 REAR 14" x 8" • 1521508-410

G CYCLONE

WEIGHT: 7.8 kg | **LOAD RATING:** 590 kg | **OFFSET:** +4
ACCENT: 15" x 7" • 1523184-266
MATTE BLACK: 15" x 7" • 1523184-458

H HALO (BEADLOCK RINGS INCLUDED)

WEIGHT: 7.7 kg | **LOAD RATING:** 726 kg | **OFFSET:** +38
ACCENT: 15" x 7" • 1523282
MATTE BLACK: 15" x 7" • 1523266

I WYDE

WEIGHT: 6.1 kg | **LOAD RATING:** 590 kg | **OFFSET:** +55
ACCENT: 15" x 7" • 1522550-266
MATTE BLACK: 15" x 7" • 1522550-458

J FLARE

WEIGHT: 8.1 kg | **LOAD RATING:** 590 kg | **OFFSET:** +4
ACCENT: 15" x 7" • 1523102-266
MATTE BLACK: 15" x 7" • 1523102-458

LUG NUTS REQUIRED



14" FORGED BEADLOCK RINGS

	PART #
A Voodoo Blue	1522244-619
B Machined	1522244-266
C White	1522244-133
D Indy Red	1522244-293
E Orange Crush	1522244-589
F Matte Black - Replacement Only used on Combat	1523146-458

Sold individually

14" SETS

WHEEL & TIRE SETS

TIRES	ATTACK 26" 4828 km	DAGGER 27" 4828 km	DUAL-THREAT 26" 4828 km	DUAL-THREAT 29" 4828 km	PRESERVE 27" 8047 km	PRO ARMOR HARVESTER 27" 8047 km	PRO ARMOR HARVESTER 28" 8047 km	CRAWLER XR 28" 4828 km
AMPLIFY Accent	2882390	2882392	2883138	2883146	2883208	2882388	2883225	2882394
AMPLIFY Matte Black	2882391	2882393	2883139	2883147	2883209	2882389	2883226	2882395
BUCKLE Accent	2881335	2881337	2883140	2883148	2883203	2882383	2883220	2881343
BUCKLE Matte Black	2881336	2881338	2883141	2883149	2883204	2882384	2883221	2881344
COMBAT Accent BEADLOCKS PRE-MOUNTED			2883217	2883219				2883213
COMBAT Matte Black BEADLOCKS PRE-MOUNTED			2883216	2883218				2883212
REBLR Matte Black BEADLOCKS SOLD SEPARATELY	2881381	2881383						2881386
SHACKLE Accent	2881347	2881349	2883142	2883150	2883205	2882385	2883222	2881355
SHACKLE Matte Black	2881348	2881350	2883143	2883151	2883206	2882386	2883223	2881356
SIXR Luster	2881359	2881362						2881371
SIXR Matte Black	2881360	2881363	2883144	2883152	2883207	2882387	2883224	2881372

EVERY 14" SET FITS ALL POLARIS GENERAL MODELS
 POLARIS GENERAL 4 '17-19,
 POLARIS GENERAL '16-19

LUG NUTS REQUIRED

15" SETS

TIRES	ATTACK 2.0 28" 4828 km	CRAWLER XG 28" 4828 km
CYCLONE Accent	2883160	2883188
CYCLONE Matte Black	2883159	2883187
FLARE Accent	2883158	2883186
FLARE Matte Black	2883157	2883185
HALO Accent BEADLOCKS PRE-MOUNTED	2883162	2883190
HALO Matte Black BEADLOCKS PRE-MOUNTED	2883161	2883189
WYDE Accent	2883156	2883184
WYDE Matte Black	2883155	2883183

EVERY 15" SET FITS ALL POLARIS GENERAL MODELS
 POLARIS GENERAL 4 '17-19,
 POLARIS GENERAL '16-19

12MM x 1.5 SPLINED LUG NUTS

LUG NUTS REQUIRED

16 SPLINED LUG NUTS WITH WRENCH ADAPTER	2879332
4 SPLINED LUG NUTS WITHOUT WRENCH	2879331
12MM x 1.5 SPLINED LUG WRENCH	2204966

REPLACEMENT CAPS

POLARIS

LUSTER	AMPLIFY, BUCKLE, COMBAT, CYCLONE, FLARE, HALO, REBLR, SHACKLE, SIXR	1521509-410
MATTE BLACK		1521509-521

PRO ARMOR

LUSTER	AMPLIFY, BUCKLE, COMBAT, CYCLONE, FLARE, HALO, REBLR, SHACKLE, SIXR	5453209-410
MATTE BLACK		5453209-458
MATTE BLACK	WYDE	1523063-458

TRACKS



PROSPECTOR PRO® TRACK SYSTEM

- Polaris exclusive optimized hub geometry minimizes feedback and eases steering effort
- Flexible lug design provides the highest level of deep snow performance by lifting up in deep snow as opposed to digging down
- Lightweight design with slight weight reduction over Camoplast® kit provides for better flotation, eases steering effort, and provides better vehicle control

PROSPECTOR PRO® TRACK MOUNTS

- Install this track system mounting hardware in place of tires and wheels. Tracks sold separately

» 2880649

POLARIS GENERAL 4 '17-19,
 POLARIS GENERAL '16-19

PROSPECTOR PRO® TRACK

» 2880758

POLARIS GENERAL 4 '17-19,
 POLARIS GENERAL '16-19

If using Glacier Pro Plow System with tracks, Track Plow Extension is required (2880257)

CHOOSE THE RIGHT WINCH

PRO PRO HEAVY DUTY SERIES

INDUSTRY 1ST TECHNOLOGY

RAPID ROPE RECOVERY 5x FASTER

RAPID ROPE RECOVERY

1. Set Winch Dial to FREE SPOOL (N) to attach Winch Hook
2. Set Winch Dial to PULL (L) for Winch Mode
3. Set Winch Dial to ROPE RECOVERY (H) for 5x Faster Rope Recovery

INTEGRATED WIRING INCLUDED

SEALED PERMANENT MAGNET MOTOR

PREMIUM SYNTHETIC ROPE

- Lightweight & Easy to Handle
- Superior Flexibility
- Greater Strength than Steel Cable
- 15 m Long

WIRELESS REMOTE

15 m range with unique code for interference-free operation

AUTO STOP TECHNOLOGY

FAIRLEAD COLLAR HOOK



Winch stops when fairlead detects collar

Auto Stop Technology stops winch at end of pull to prevent driveline stress and plow overlifting

HD HEAVY DUTY SERIES

CUT STEEL GEARS & SEALED DRIVETRAIN

HOOK WITH STRAP

3 STEPS FOR ADDING A WINCH:					
1 FIND YOUR MACHINE		2 CHOOSE BETWEEN POLARIS PRO HD OR POLARIS HD WINCH		3 ADD CABLES	
FITMENT	MODEL	PRO PRO HEAVY DUTY SERIES 2041 kg	HD HEAVY DUTY SERIES 2041 kg 1588 kg	REQUIRED BATTERY CONNECTION CABLES	
	POLARIS GENERAL 4 '19 POLARIS GENERAL '19	AVAILABLE IN FALL NEW 2883861	AVAILABLE IN FALL NEW 2883860		
	POLARIS GENERAL 4 '17-18 POLARIS GENERAL '16-18	2882239	2882477 2882476	Polaris GENERAL '16-18 Requires 2882373	
FEATURES	RAPID ROPE RECOVERY	STANDARD			
	AUTO STOP TECHNOLOGY	STANDARD	OPTION		
	WINCH LINE	SYNTHETIC	STEEL CABLE		
	FAIRLEAD	ALUMINUM	STEEL ROLLER		
	REMOTE	WIRELESS	STANDARD WIRED		

UPGRADE YOUR POLARIS HD WINCH WITH THESE ACCESSORIES

POLARIS WIRELESS WINCH REMOTE

- Allows for remote operation of Polaris HD winch
 - Up to 15 m range with LED indicator
 - Direct plug and play operation
- » 2881287
WORKS WITH 2882476, 2882477, 2883860
POLARIS GENERAL '16-19

SYNTHETIC WINCH ROPE

- 2041 kg WINCH SERIES
» 2879187
POLARIS GENERAL '16-19
- 1588 kg WINCH SERIES
» 2878888
POLARIS GENERAL '16-19

AUTO STOP TECHNOLOGY WINCH UPGRADE

- Machined from billet aluminum and weighs less than common steel fairleads
 - Installs easily in place of stock fairlead
 - Requires synthetic winch rope (not included) (not compatible with steel cable)
- » 2041 kg • 2881288
» 1588 kg • 2881289
POLARIS GENERAL 4 '17-19,
POLARIS GENERAL '16-19

DASH SWITCH HARNESS

- » 2882373
POLARIS GENERAL 4 '17-19,
POLARIS GENERAL '16-19
REQUIRED ON ABOVE MODELS TO ADD WINCH

WINCH WIRING KIT

- » 2-SEAT • 2879388
POLARIS GENERAL '16-19
REQUIRED ON ABOVE MODELS TO ADD WINCH
- » 4-SEAT • 2879685
POLARIS GENERAL 4 '17-19
REQUIRED ON ABOVE MODELS TO ADD WINCH

THERE'S A REASON THESE ARE THE BEST WINCHES ON THE MARKET.

Polaris winches are fully sealed to keep out water, dust and other debris.



TESTED 1,200+ PULLS AT MAX LOAD, IT WORKS WHEN YOU NEED IT TO



SEALED MOTOR & HEAVY DUTY GEARS OPERATE FULLY SUBMERGED UNDERWATER



BUILT TO WITHSTAND -29° C TEMPERATURES



MILITARY TESTED & APPROVED

PUSH FOR MORE

GLACIER® PRO HD GIVES YOU » 183 cm OR 168 cm Blades » Choice of poly or steel » Manual angle system standard

GLACIER® PRO HD PLOW SYSTEM



MAKE QUICK WORK OF SMALLER JOBS

Move snow with the robust and capable Glacier® HD plow system, and discover why a major snowfall can be the highlight of your week. With a robust frame, beefy poly and steel blade options, convenient Lock & Ride mounting and dismantling and amazing value, Glacier® HD is a great choice in the dead of winter.

BLADE MATERIAL

Durable poly and steel blades are designed to push more. Choose a steel blade for longevity and increased rigidity or a lightweight non-stick, poly blade that's easier on plowing surfaces.



	STEP 1 SELECT A MOUNT	STEP 2 SELECT A FRAME	STEP 3 SELECT A LIFT METHOD	STEP 4 SELECT A BLADE	STEP 5 SELECT ACCESSORIES
MODELS	MOUNT	FRAME	WINCH	BLADES	ACCESSORIES
POLARIS GENERAL 4 '17-19,	2881763	2880260	Polaris PRO HD 2041 kg Winch 2883861 POLARIS GENERAL 4 '19, POLARIS GENERAL '19	183 cm Steel 2880270 168 cm Poly 2880269	183 cm Blade Snow Deflector 2858541 183 cm HD Wear Bar 2879875 183 cm Wear Bar 2204976 168 cm Blade Snow Deflector 2879866 168 cm HD Wear Bar 2879868 168 cm Wear Bar 2879867 Plow Marker 2872726 Skid Shoe 2205071 Shear Pin 2205527 Extension for Tracks 2880267
POLARIS GENERAL '16-19			Polaris PRO HD 2041 kg Winch 2882239 POLARIS GENERAL 4 '17-18, POLARIS GENERAL '16-18	168 cm Steel 2880268	

GLACIER® HD GIVES YOU » 168 cm Blades » Choice of poly or steel » Manual angle system standard

GLACIER® HD PLOW SYSTEM



	STEP 1 SELECT A MOUNT	STEP 2 SELECT A FRAME	STEP 3 SELECT A LIFT METHOD	STEP 4 SELECT A BLADE	STEP 5 SELECT ACCESSORIES
MODELS	MOUNT	FRAME	WINCHES	BLADES	ACCESSORIES
POLARIS GENERAL 4 '17-19,	2883256	2882927	Polaris PRO HD 2041 kg Winch 2883860 POLARIS GENERAL 4 '19, POLARIS GENERAL '19	168 cm Poly 2880269 168 cm Steel 2880268	168 cm Blade Snow Deflector 2879866 168 cm HD Wear Bar 2879868 168 cm Wear Bar 2879867 Plow Marker 2872726 Skid Shoe 2205071 Shear Pin 2205527
POLARIS GENERAL '16-19			Polaris HD 2041 kg Winch 2882477 POLARIS GENERAL 4 '17-18, POLARIS GENERAL '16-18		
			Polaris HD 1558 kg Winch 2882476 POLARIS GENERAL 4 '17-18, POLARIS GENERAL '16-18		

ACCESSORIES

WINDSHIELDS & REAR PANELS

DOORS

ROOFS & PROTECTION

TECH, AUDIO & LIGHTING

STORAGE & COOLERS

WHEELS & TIRES

WINCHES & PLOWS



SPECIFIC NEEDS, *SPECIFIC OILS*

Polaris invests millions in engine development, and part of that investment is making sure its lubricants—critical to engine performance—are the right formula for your specific engine. The amount of testing data and engineering resources used in developing Polaris lubricants would overwhelm an aftermarket company. Therefore, the aftermarket must spec an oil to an industry-wide standard that must account for a variety of operating parameters.

PS-4 is designed specifically for Polaris 4-cycle engines and has high film strength and wear protection under extreme loads and temperatures. Exclusive anti-wear additives protect engine parts with extra rust and corrosion protection.

PS-4 FULL-SYNTHETIC OIL

• PS-4 is optimal for ambient operating temperatures of -40° C to 38° C

- » 1L • 2877263
- » 4L • 2877264
- » 25 L • 2877868
- » 60 L • 502338
- » 200 L • 2878003

PS-4 OIL CHANGE KIT

• Contains the correct amount of oil for your vehicle and correct oil filter

- » 2202166
SINGLE 570, TWIN 600, TWIN 700, TWIN 800
- » 2879323
RANGER/RZR 900/1000
- » 2880913
POLARIS ACE/ETX 325
- » 2877473
330500, SPORTSMAN 550/850/1000

PS-4 EXTREME-DUTY FULL-SYNTHETIC OIL

• PS-4 Extreme Duty is optimal for ambient operating temperatures of -18° C to 53° C

- » 1L • 2879037
- » 4L • 2879251
- » 25 L • 2879252
- » 60 L • 2879003
- » 200 L • 2879038

POLARIS® PS-4 VS THE COMPETITION

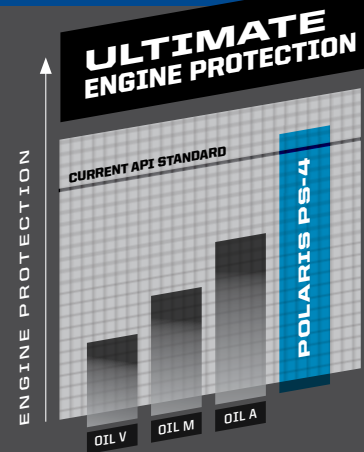

Polaris PS-4 oils exceed the latest industry protection standard as set by the API, while the competition uses standards from years ago. Our proprietary additives clean and protect critical engine parts under high operating temperatures.

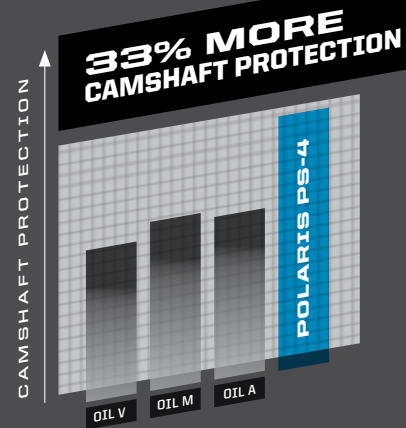

When tested against competitive oils, camshaft bearing races and lobes exhibit less wear when protected by Polaris PS-4 oil.

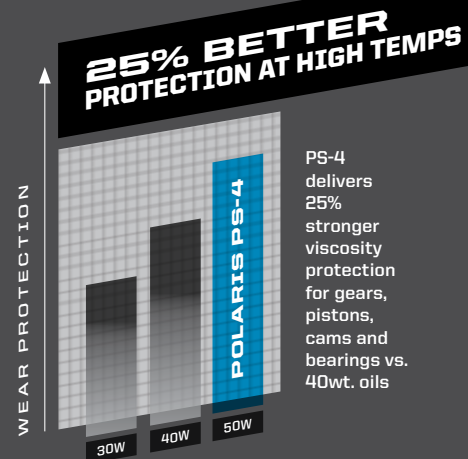

WHY VISCOSITY MATTERS: Polaris engines are designed to operate using oils rated at a specific viscosity. Viscosity is the measure of an oil's resistance to flow and shear and a way to gauge an oil's "film strength", which is a critical component in preserving engine life when an oil is subject to high heat or heavy loads.

ENGINEERED TO MAXIMIZE THE LIFE OF YOUR RIDE

All Polaris fluids—from anti-freeze to brake fluid—are developed for your vehicle. Trust the only fluids perfectly engineered for your needs.



DOT 4 BRAKE FLUID

Polaris DOT 4 Brake Fluid is a high-quality brake fluid designed for use in Polaris hydraulic brakes. Superior high-temp characteristics plus anti-corrosive additives extend the life of brake system components and provide consistent, positive braking.

- » 250 mL • 502081

ANTI-FREEZE

Polaris Extended Life Coolant contains organic acid technologies to prevent corrosion on metal components, eliminate scaling, and maximize cooling system performance.

- » 1 L • 502103
- » 25 L • 502271
- » 206 L • 502091

AGL

A proprietary blend of additives designed to optimize Polaris' ORV transmission life. Extreme pressure additives protect gears, drive chain, and bearings from scoring and wear. Unlike typical gear case oils, AGL's unique viscosity range allows instant flow and film protection in extreme cold or high heat environments.

- » 1 L • 502080
- » 200 L • 502151
- » 25 L • 502152

DEMAND DRIVE FLUID

Engineered specifically for Polaris ORV front drive systems. Provides positive 4WD engagement in extreme cold or high heat conditions. Unique friction additives protect internal components under heavy loads and promote positive engagement.

- » 1 L • 502094
- » 200 L • 502264
- » 25 L • 502267

Proper lubricant application and timing will ensure optimal vehicle performance. Please refer to your owner's manual for lubricant change interval schedules.



CARBON CLEAN

Polaris Carbon Clean prevents ethanol corrosion, stabilizes fuel, and cleans fuel injectors, piston ring lands, intake systems, and combustion chambers. Helps maintain peak HP and improves fuel economy.

- » 125 mL • 502082



FUEL STABILIZER

Fuel Stabilizer prevents ethanol corrosion and stabilizes fuel for up to 2 years. Dual-antioxidant formula protects against gum and varnish for easy starting.

- » 125 mL • 502100



ANGLE DRIVE FLUID

SPORTSMAN, RANGER, RZR ANGLE DRIVE GEAR CASE SYSTEMS

- » 1 L • 502089
- » 25 L • 502268
- » 202 L • 502266



PREMIUM GAS SHOCK OIL

- » 1 L • 502098



ALL-SEASON GREASE TUBE

- » 400 g • 502068

FOR THE LIFE OF YOUR RIDE

THE KEY TO KEEPING YOUR POLARIS OFF-ROAD VEHICLE PERFORMING as well as the day you brought it home is proper maintenance. Items like belts, filters, and batteries represent only a few of these critical items engineered specifically by Polaris.

AIR FILTERS

Critical to engine performance and reliability. A clogged air filter can restrict air flow to the engine leading to reduced engine performance. Dirt and debris ingestion can damage the engine leading to reduced engine life or catastrophic failure. Polaris recommends changing the vehicle's air filter at the specified intervals outlined in the owner's manual, which may be shorter if your vehicle is subject to severe conditions.

BRAKE PADS

Check your brakes if you are close to the recommended service interval, hear grinding when applying the brakes, your vehicle is taking longer to stop or if you have to apply more pressure to your pedal to engage the brakes. Check the brake discs for signs of cracks, excessive corrosion or warping.

If the brake pads are contaminated with oils or grease (petroleum products), brake pads have to be discarded and replaced.

Discs need to be cleaned with brake cleaner or alcohol based cleaner only.

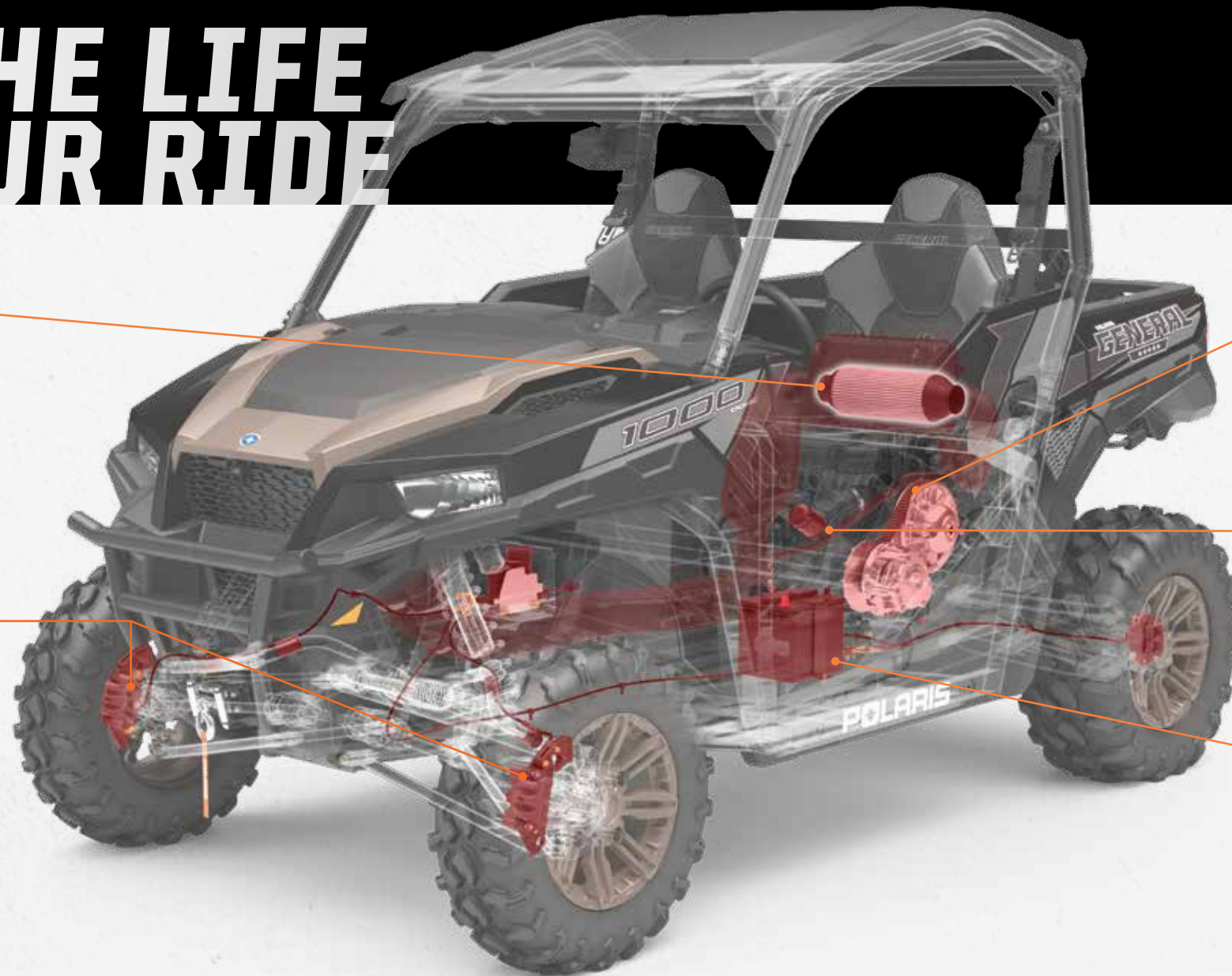

DRIVE BELTS

Polaris Engineered belts deliver unmatched performance for your off-road vehicle. Developed and tested on all our engines for all environments and conditions. Check your belt for delamination, hour glassing and glazing.

OIL FILTERS

Change oil filters with every oil change to provide the best protection for your engine. Superior engine protection keeps your engine operating at peak performance. Be sure to follow the suggested service intervals for oil/oil filter changes.

BATTERIES

Never leave a battery unattended during the storage season. To ensure your battery maintains its level of charge when unused for extended periods of time or during freezing weather, the battery should be connected to a BatteryMINDER. Be sure to check for corrosion from the terminals to the ends of the cables.

MAINTENANCE TIP

BREAK-IN PERIOD

The break-in period for your new Polaris GENERAL is the first 25 hours of operation, or the time it takes to use the first two tanks of fuel. No single action on your part is as important as a proper break-in period. Careful treatment of a new engine will result in more efficient performance and longer life for the engine. Perform the listed procedures carefully.

NOTICE: Excessive heat build-up during the first three hours of operation will damage close-fitted engine parts. Do not operate at full throttle or high speeds for extended periods during the first three hours of use.

MAINTENANCE SCHEDULE

25 HRS/400 km	50 HRS/800 km	100 HRS/1600 km	150 HRS/2400 km	200 HRS/3200 km	350 HRS/4020 km	500 HRS/8045 km	CHECK YOUR OWNER'S MANUAL FOR ADDITIONAL RECOMMENDED SERVICE ITEMS AND VEHICLE-SPECIFIC TIMING
BREAK-IN MAINTENANCE ENGINE OIL: CHANGE GENERAL LUBRICATION: ALL FITTINGS, PIVOTS, CABLES, ETC. AIR FILTER: INSPECT & CLEAN REPLACE AS NEEDED EXHAUST SYSTEM: INSPECT & CLEAN INSPECT FOR LEAKAGE OR CARBON BUILD UP AT JOINTS INSPECT & CLEAN SCREEN TYPE SPARK ARRESTOR	6 MONTHS EXHAUST SYSTEM: INSPECT & CLEAN INSPECT FOR LEAKAGE OR CARBON BUILD UP AT JOINTS INSPECT & CLEAN SCREEN TYPE SPARK ARRESTOR GENERAL LUBRICATION: ALL FITTINGS, PIVOTS, CABLES, ETC. DRIVE BELT: INSPECT & ADJUST REPLACE AS NEEDED	12 MONTHS ENGINE OIL: CHANGE DRIVE BELT: INSPECT & ADJUST REPLACE AS NEEDED TRANSMISSION FLUID: CHANGE EXHAUST SYSTEM: INSPECT & CLEAN INSPECT FOR LEAKAGE OR CARBON BUILD UP AT JOINTS INSPECT & CLEAN SCREEN TYPE SPARK ARRESTOR	18 MONTHS ENGINE OIL: CHANGE BATTERY: TEST, CLEAN, & CHECK FLUID LEVEL REPLACE AS NEEDED DRIVE BELT: INSPECT & ADJUST REPLACE AS NEEDED TIRES: INSPECT CONDITION & PRESSURE EXHAUST SYSTEM: INSPECT & CLEAN INSPECT FOR LEAKAGE OR CARBON BUILD UP AT JOINTS INSPECT & CLEAN SCREEN TYPE SPARK ARRESTOR	24 MONTHS ENGINE OIL: CHANGE BRAKE PADS & FLUID: INSPECT & CLEAN REPLACE AS NEEDED SPARK PLUGS: INSPECT REPLACE AS NEEDED EXHAUST SYSTEM: INSPECT & CLEAN INSPECT FOR LEAKAGE OR CARBON BUILD UP AT JOINTS INSPECT & CLEAN SCREEN TYPE SPARK ARRESTOR	30 MONTHS ENGINE OIL: CHANGE BATTERY: TEST, CLEAN, & CHECK FLUID LEVEL REPLACE AS NEEDED DRIVE BELT: INSPECT & ADJUST REPLACE AS NEEDED GENERAL LUBRICATION: ALL FITTINGS, PIVOTS, CABLES, ETC. EXHAUST SYSTEM: INSPECT & CLEAN INSPECT FOR LEAKAGE OR CARBON BUILD UP AT JOINTS INSPECT & CLEAN SCREEN TYPE SPARK ARRESTOR	36 MONTHS ENGINE OIL: CHANGE AIR FILTER: INSPECT, CLEAN REPLACE AS NEEDED COOLANT: CHECK LEVEL REPLACE EVERY 2 YEARS GEARCASES: CHECK OIL LEVEL EXHAUST SYSTEM: INSPECT & CLEAN INSPECT FOR LEAKAGE OR CARBON BUILD UP AT JOINTS INSPECT & CLEAN SCREEN TYPE SPARK ARRESTOR	

SERVICE PARTS

Polaris Engineered service parts deliver unmatched performance and fit for your off-road vehicle.

All service parts are developed and tested for your vehicle. Half shafts, bushings, bearings, decals, side panels, electrical components, and clutching components are the same parts that are manufactured on the factory lines for each specific vehicle. This ensures it doesn't merely fit your vehicle - it outperforms your expectations!

VISIT YOUR POLARIS DEALER TO SHOP FOR SERVICE PARTS.

OVER
100,000
PARTS
AVAILABLE!



FOR THE LIFE OF YOUR RIDE

Maintenance is the key to keeping your Polaris off-road vehicle performing at its peak. Items like belts, lubricants, and batteries represent only a few of these critical items engineered specifically by Polaris.



POLARIS ENGINEERED DRIVE BELTS

TESTED, PERFECTED

We test each belt on the intended vehicle - we don't just try to make an existing belt "just work".

- Amery Kuhl, Polaris® CVT System Engineer

OUR INVESTMENT

- 32,187 km of field testing
- Thousands of dyno hours
- 18+ months of development (3,000+ design hours) per belt
- 1200+ vehicle validation hours
- Collaboration with powertrain & clutch engineers

YOUR ADVANTAGE

- No clutch recalibration
- Less wear & tear due to heat
- Ensure maximum performance of your vehicle
- More time out riding, less time wrenching

**OUR INVESTMENTS ENSURE POLARIS BELTS
OUTPERFORM YOUR EXPECTATIONS.**

BRING IT EVERYWHERE

TRAILERING



RAMP PRO BY CALIBER®

- Designed for ATVs and UTVs up to 127 cm wide
 - Integrated grip glides for ultimate traction
 - Folding sides for easy transportation & storing
- » 132 cm x 229 cm • 2883005



ALUMINUM ARCHED LOADING RAMPS

- » 193 cm x 30.5 cm • 907 kg • 2875384
- » 224 cm x 30.5 cm • 1361 kg • 2875386



LIGHTWEIGHT TRI-FOLD RAMPS

- Ramp folds up for transport
 - Capacity for up to 680.7 kg
 - Safety straps included
- » 183 cm x 130 cm • 2875385
» 208 cm x 130 cm • 2875860

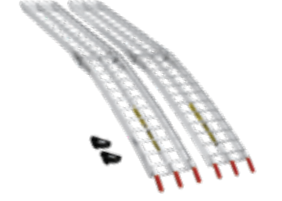

FOLDING ALUMINUM ARCHED RAMPS

- Ramp folds up for transport
 - Capacity up to 1361 kg
 - Safety straps included
- » 224 cm x 30.5 cm • 2875387

HITCHES

3:1 HITCHES VERSATILE 3 IN 1 FUNCTIONALITY

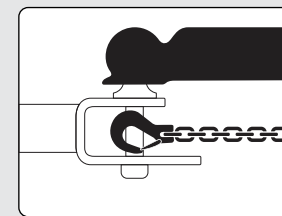

BALL

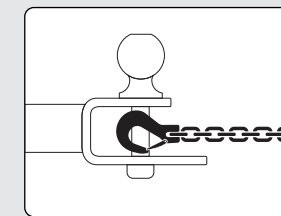

HOOK

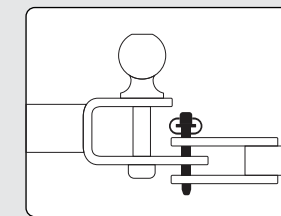

PIN

- Ball, pin and hook design
- Durable steel construction
- Rust resistant, black powdercoated finish
- Removable ball
- Heavy Duty 5/8" pin and clip



NEW HITCH WITH 2" BALL

- » 2" x 2" RECEIVER 2830522
- » 1 1/4" x 1 1/4" RECEIVER 2830523



NEW 1 7/8" BALL

- 1 7/8" replacement ball for hitch
 - Designed to work with 3:1 Hitch
- » 2830524



RECEIVER HITCH

- » 2" RECEIVER TONGUE 2875320
- » FRONT HITCH RECEIVER 2878846



TRAILER BALL 3/4" SHANK

- » 1 7/8" BALL • 2877602
- » 2" BALL • 2877603

STRAPS & ROPES

NEW RECOVERY STRAP

- 5cm x 9.1 m (8165 kg)
 - Comes with carry bag
- » 2884033



NEW RATCHET STRAP

- 3.8 cm x 4.6 m straps, 2 Pack
 - Heavy duty webbing
 - 2495 kg maximum load, 831 kg working load
- » 2884031

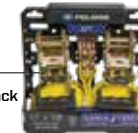

NEW RATCHET STRAP

- 5 cm x 6.1 m Ratchet Straps
 - Heavy duty webbing, floating D-rings, double J-hooks
 - 4536 kg maximum load, 1497 kg working load
- » 2884032



SHOCK STRAPS

- 3.8 cm 1361 kg breaking strength
 - Keeps tension on tie-down straps to secure load, 2 Pack
- » 3.8 cm x 4.6 m • 2883296
» 3.8 cm x 2.1 m • 2883295

COVERS



TRAILERABLE COVER BY POLARIS

- » 2-SEAT • 2881841
POLARIS GENERAL 4 '16-19
- » 4-SEAT • 2881787
POLARIS GENERAL 4 '17-19



POLARIS SxS CAMO FIELD COVER

- » 2882160
POLARIS GENERAL 4 '17-18,
POLARIS GENERAL '16-18

KEEP IT CLEAN

CLEAN ALL-PURPOSE CLEANER

- Professional cleaner, which is formulated with a low pH-value. The product spreads well on surfaces and adheres on them for effective cleaning action. Perfectly compatible with rubber, plastic and painted surfaces. The formulation is biodegradable.

» 500 mL • 502309

SHINE INSTANT SHINE & DETAILER

- The INSTANT SHINE AND DETAILER is developed for cleaning action without water. Removes insects, dust and dirt with almost no effort. Applicable for plastics, visors, windscreens, paint and metal. The wipe and shine formulation makes surfaces shine, works water repellent and also has an antistatic effect. Perfect for customers living in urban areas with no access to water, for bike trips or showroom bikes.

» 500 mL • 502303



**KINGPIN DIRT
509 GOGGLE**

- ECE Certified & DOT Approved
- Quick change lens & triple layer foam
- Anti-fog & anti scratch
- » ONE SIZE
2868671 • LIME
2868668 • ORANGE

**ORV RIDING
JERSEY**

- » S-3XL
2868711 • LIME
2867941 • PINK
2867942 • RED



SOFTSHELL JACKET

- Lined with 280 grams of fleece for warmth
- Removable hood
- Armpit zips for venting
- » S-3XL
- » MEN'S
2869919 • BLUE/ORANGE
2869918 • BLACK
- » WOMEN'S
2869921 • CORAL
2869920 • BLACK



**FIND YOUR
PERFECT HELMET!**

RIDE SAFE - OUR HELMETS ARE DOT/ECE CERTIFIED



**509° ALTITUDE
CARBON HELMET**

- Durable, ultra lightweight, Carbon Fiber
- Full carbon fiber shell
- 1100 grams
- » S-4XL
2867814 • MATTE BLACK
2867815 • GLOSS BLACK



509° ALTITUDE HELMET

- Stylish, Lightweight with 509 Fit and Finish
- Thermoplastic poly alloy out shell
- 1260 grams

- » S-4XL
2868539 • LIME
2867820 • BLUE
2867818 • ORANGE
- 2867819 • RED
2867817 • GRAY



TENACITY HELMET

- All the style and protection in our most affordable helmet
- Injection molded plastic
- 1450 grams

- » XS-3XL
2868624 • PINK GLOSS
2868620 • BLACK/GRAY
2868622 • BLUE GLOSS
- 2868619 • BLACK MATTE
2868623 • RED GLOSS
2868621 • LIME GLOSS

PROTECT YOUR HANDS

OFF-ROAD RIDING GLOVES

- As seen in images at left
- » S-3XL
2867937 • PINK
2867933 • GRAY
2868712 • BLUE/LIME
- 2867936 • RED
2867935 • ORANGE
2867934 • BLUE

BE PREPARED FOR ANYTHING NATURE

THROWS AT YOU

COOLING SHIRTS

- 100% Poly, chemical-free patented fabric from CoolCore®
- Moisture wicking to keep you dry and cool
- UPF 45+
- » S-3XL
- » MEN'S
2868753 • GRAY
- » WOMEN'S
2868755 • GRAY/PINK



**NEW
RAIN SUIT**

- Lightweight
- Waterproof
- Packs small
- Removable hood
- YKK® zippers
- » JACKET • 2869527
S-3XL
- » PANT • 2869528
S-3XL

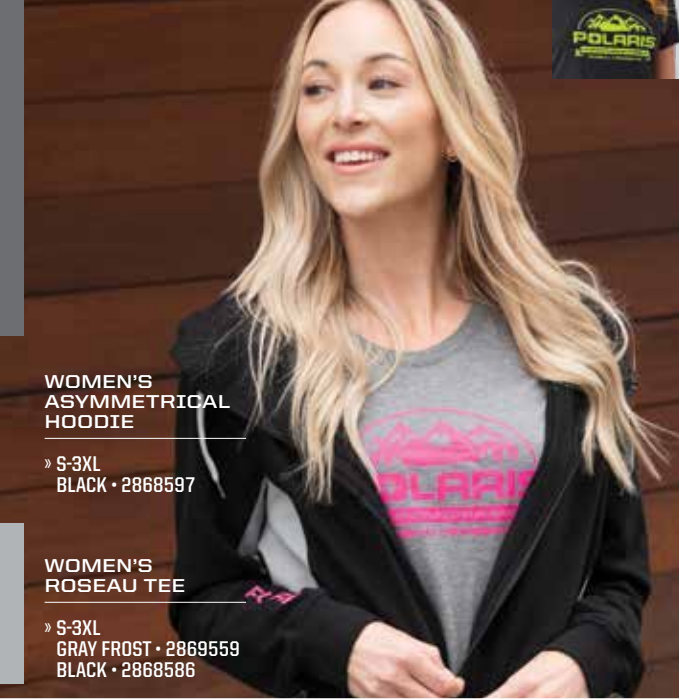

WOMEN'S ASYMMETRICAL HOODIE

» S-3XL
BLACK • 2868597

WOMEN'S ROSEAU TEE

» S-3XL
GRAY FROST • 2869559
BLACK • 2868586

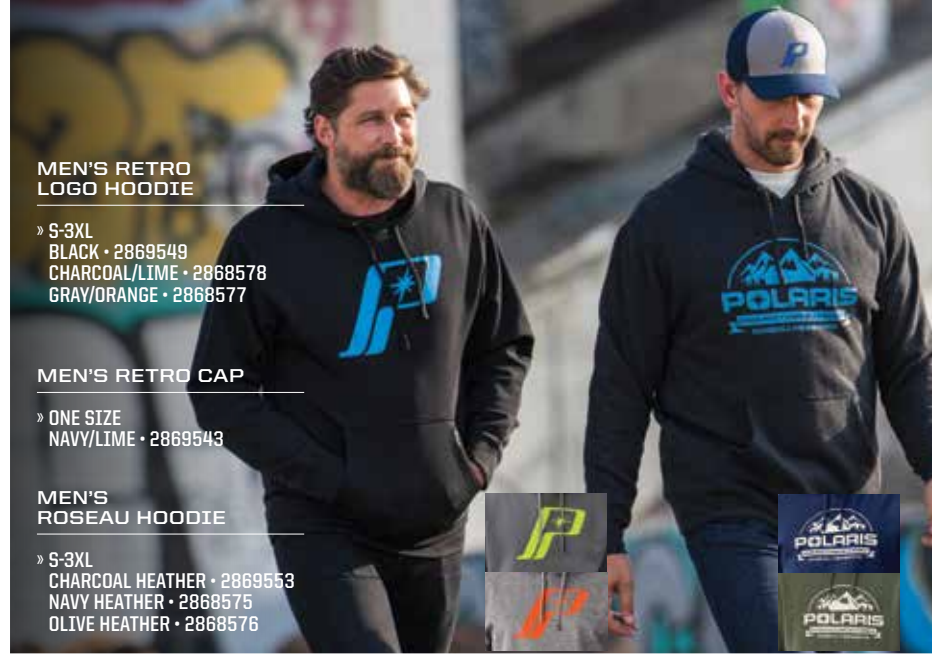

MEN'S RETRO LOGO HOODIE

» S-3XL
BLACK • 2869549
CHARCOAL/LIME • 2868578
GRAY/ORANGE • 2868577

MEN'S RETRO CAP

» ONE SIZE
NAVY/LIME • 2869543

MEN'S ROSEAU HOODIE

» S-3XL
CHARCOAL HEATHER • 2869553
NAVY HEATHER • 2868575
OLIVE HEATHER • 2868576



MEN'S LONG SLEEVE TECH 1/4 ZIP

» S-3XL
BLACK/RED • 2869535
GRAY/LIME • 2869536



MEN'S TECH MESH BEANIE

» ONE SIZE
BLACK • 2868650

MEN'S TRAIL MID LAYER

» S-3XL
GRAY/BLACK • 2869925



CAMO WATER BOTTLE

» 2867962

CAMO COFFEE TRAVEL MUG

» 2867961

CAMO BOTTLE KOOZIE

» 2867964

CAMO CAN KOOZIE

» 2867963

CAMO STEERING WHEEL COVER

» 2868663

CAMO BOTTLE OPENER [NOT SHOWN]

» 2867965



WOMEN'S CAMO HOODIE

» S-3XL
CAMO/PINK • 2867898

MEN'S CAMO TECH FULL ZIP

» S-3XL
CAMO • 2869590



MEN'S RETRO TRUCKER CAP

» ONE SIZE
RED • 2869540

MEN'S LONG SLEEVE RETRO TEE

» S-3XL
GRAY • 2868571

WOMEN'S BASEBALL 3/4 SLEEVE TEE

» S-3XL
WHITE/GRAY • 2869563



PINT GLASS SET OF 2

» 2866265

RETRO CLOCK

» 2868662



MEN'S POLARIS GENERAL CAP

» GRAY
S/M • 2868748
L/XL • 2868749

MEN'S POLARIS GENERAL TEE

» S-3XL
GRAY • 2868767



MEN'S ESTA TEE

» S-3XL
CHARCOAL HEATHER • 2869552
NAVY • 2869562
BLACK • 2868570

MEN'S FULL ZIP HOODIE

» S-3XL
BLACK/RED • 2869530
NAVY • 2869532 [NOT SHOWN]

MEN'S RETRO CAP

» ONE SIZE
CHARCOAL • 2869542



WOMEN'S HEX TEE

» S-3XL
GRAY FROST • 2869566
NAVY FROST • 2869565

WOMEN'S RETRO CAP

» ONE SIZE
BLUE • 2869547

WOMEN'S SCRIPT CREW SWEATSHIRT

» S-2XL
AQUA • 2869557

WOMEN'S RETRO HOODIE

» S-3XL
NAVY • 2869555



MEN'S ROSEAU TEE

» S-3XL
CHARCOAL HEATHER • 2869560
HEATHER BLUE • 2867778
ASH HEATHER • 2869561

FIND YOUR NEXT ADVENTURE



UNLESS NOTED, TRADEMARKS ARE THE PROPERTY OF POLARIS INDUSTRIES INC. SOB® is a registered trademark of Teton Outfitters, LLC. BatteryMinder® is a registered trademark of VDC Electronics Inc. Can-Am® and COMMANDER® are registered trademarks of Bombardier Recreational Products Inc. CREE® is a registered trademark of Cree, Inc. Caliber is a registered trademark of Caliber, Inc. CDD CORE® is a registered trademark of Tempology LLC. MTX® is a registered trademark of Mitel Corporation. Rigid® is a registered trademark of Rigid Hitch, Inc. Yeti® is a registered trademark of Yeti Coolers, LLC. YKK® is a registered trademark of YKK Corporation. Bluetooth® is a registered trademark of Bluetooth SIG, Inc. Camoplast® is a registered trademark of Camoplast Solideal Inc. FOX® is a registered trademark of Fox Factory Inc. GoPro® is a registered trademark of GoPro Inc. Homelink® is a registered trademark of Johnson Controls Technology Inc. Maxxis® is a registered trademark of Cheng Shin Rubber Ind. Co., Ltd. Walker Evans® is a registered trademark of Walker Evans Enterprises Corp. Prices and availability are subject to change at any moment. Copyright © 2018 Polaris Industries, Inc. All rights reserved.

Availability varies by market, check your local dealer for availability.